



# NEW ZEALAND PONY CLUBS TEAM MOUNTED GAMES 2006

(Updated October 2010)

**Organised by the  
New Zealand Pony Clubs Association Inc.**

## CONTENTS

<b>I. ZONE FINALS</b> .....	5
Rule 1: The Form of the Competition .....	5
Rule 2: The Objects .....	5
Rule 3: When and Where Held .....	5
Rule 4: Scoring .....	6
<b>II. ORGANISING COMMITTEES</b> .....	7
Rule 5: NZPCA Games Committee .....	7
Rule 6: Area Committee for Zone Final .....	8
<b>III. ENTRIES FOR ZONE FINALS</b> .....	10
Rule 7: Area Teams — Riders and Mounts .....	10
Rule 8: Entry Details, Entry Fees and Closing Date .....	11
Rule 9: Amendment to Entries .....	11
Rule 10: Team Manager/Coach Duties and Responsibilities .....	12

<b>IV. AREA GAMES TRIALS</b> .....	12
Rule 11: Area Committee Responsibilities .....	12
Rule 12: District Commissioners Responsibilities .....	12
<b>V. ISLAND AND NATIONAL CHAMPIONSHIPS</b> .....	13
Rule 13: The Form of the competition .....	13
Rule 14: The Objects .....	13
Rule 15: Area Teams — Riders and Ponies .....	14
Rule 16: Entries .....	14
Rule 17: Scoring .....	15
Rule 18: NZPCA Games Committee .....	15
<b>VI. GENERAL RULES</b> .....	15
Rule 19: Dress and Saddlery Inspection .....	15
Rule 20: Dress .....	16
Rule 21: Saddlery and Equipment .....	16
Rule 22: Legal Liability .....	19
Rule 23: Concussion and Injury .....	19
Rule 24: Temporary Pens .....	19
Rule 25: Objections .....	19
Rule 26: Doping - Mounts .....	20
Sports Anti-Doping Policy - Riders .....	21
Rule 27: General Rules .....	21
<b>VII. DUTIES OF THE OFFICIALS</b> .....	26
Rule 28: Official Steward .....	26
Rule 29: Chief Judge .....	27
Rule 30: Chief Gear Inspector .....	27
Rule 31: Starter .....	27
Rule 32: Time Keepers .....	28
Rule 33: Lane Stewards .....	28
Rule 34: Scorer .....	30
Rule 35: Commentator .....	30
Rule 36: Arena Party .....	30
<b>NEW ZEALAND PONY CLUBS TEAM MOUNTED GAMES</b> .....	31
1. Anti Litter race .....	32
2. Aunt Sally race .....	33
3. Ball and Bucket race .....	34
4. Ball and Cone race .....	35

5. Ball and Racquet race .....	36
6. Balloon Bursting race .....	37
7. Bending race .....	38
8. Bottle race .....	39
9. Canadian race .....	40
10. Carton race.....	41
11. Egg and Racquet race.....	42
12. Egg and Spoon race.....	43
13. Fishing race.....	44
14. Five Flag race.....	45
15. Five Mug race.....	46
16. Grooms Stakes.....	47
17. Hi Lo race .....	48
18. Housewife's Scurry.....	49
19. Hurdle race.....	50
20. Knickerbocker Glory.....	51
21. Litter race.....	52
22. Milk race .....	53
23. Motor Tyre race .....	54
24. Mug Shuffle .....	75
25. Newspaper race .....	56
26. Nine Ring race.....	57
27. Old Sock race.....	58
28. Pony Club Pole race .....	59
29. Pony Club race .....	60
30. Pony Express race .....	61
31. Postman's Chase .....	62
32. Potato Picking Scramble .....	63
33. Potato race.....	64
34. Pyramid race .....	65
35. Ring race .....	66
36. Rope race.....	67
37. Run and Ride.....	68
38. Sack race.....	69
39. Sharp shooters race.....	70
40. Stepping Stone Dash.....	71
41. Sword race .....	72
42. Tack Shop race.....	73

43. Three Legged Sack race.....	74
44. Three Mug race.....	75
45. Two Flag race.....	76
46. Windsor Castle race.....	77

*NOT CONSIDERED TEAM RELAY GAMES:*

47. Barrel race .....	78
48. Keyhole race .....	79

Appendix 1 - General .....	80
- Notes to the Arena Plan.....	80
- Plan of Arena .....	81

Appendix 2 - The Briefing.....	82
--------------------------------	----

Appendix 3 - Explanatory note for Rule 20(g) Dress .....	83
--	----

Appendix 4 - Prohibited Substances .....	84
--	----

Appendix 5 - Snaffle Bits permitted for NZPCA Team Mounted Games ..	86
---	----

# **NEW ZEALAND PONY CLUBS TEAM MOUNTED GAMES ZONE FINALS**

## **RULES AND REGULATIONS**

### **I. INTRODUCTORY RULES**

#### **RULE 1: THE FORM OF THE COMPETITION**

- (a) The competition is an annual Branch or Club (if said Club has no Branches) Team Mounted Games competition, played in six Zone Finals throughout New Zealand.
- (b) The number of Games, either six or eight, and the Games to be played, will be set annually by the NZPCA. Two of the games will be nominated as tie breaker games in the event of equality of points for placings. (see Rule 4 (h) Scoring).

#### **RULE 2: THE OBJECTS**

- (a) The object of the Competition is to provide Pony Club members with a competition in games requiring courage, determination and all round riding ability on the part of the rider and careful and systematic training of the pony.
- (b) To encourage a higher standard of games riding throughout Pony Club and to stimulate among the future generations a greater interest in riding as a sport and as recreation.
- (c) To encourage Team participation within the objects of the NZ Pony Clubs Association Inc., and to abide by the principles of the NZPCA Fair Play Charter.

#### **RULE 3: WHEN AND WHERE HELD**

The competition will be held annually as determined by the NZPCA. The grouping of Areas, to be known as Zones, is as follows:

- Zone 1:** Auckland  
Franklin Thames Valley  
Northland  
Waitemata Rodney
- Zone 2:** Bay of Plenty  
Gisborne Wairoa  
King Country  
Waikato
- Zone 3:** Hawke's Bay  
Manawatu West Coast  
Taranaki  
Wairarapa Wellington
- Zone 4:** Marlborough Nelson West Coast
- Zone 5:** Ashburton South Canterbury North Otago and  
Canterbury
- Zone 6:** Otago Southland

- Notes: (a) The competition will be rotated around the Areas within each Zone except Zones 4 and 6.
- (b) The number of Branch Teams per Area will be confirmed annually.

#### **RULE 4: SCORING**

- (a) Heats for each game will be timed and the six fastest times of each game will go forward to the Final of that game at the completion of all heats.
- (b) Points will be awarded in the final of each game.
- (c) The winning team will score one point more than the number of teams competing in the final. The second team will score one point less and so on, so that the last team scores 2 points, eg six competing teams score as follows; first - 7 points, second - 6 points, third - 5 points, fourth - 4 points, fifth - 3 points, sixth - 2 points.
- (d) Eliminated teams score 1 point.
- (e) Disqualified teams score 0 points.
- (f) In the case of equal placings in a game (including when two or more teams are eliminated) the points will be divided equally.

e.g. for equal first placing the points for first (7) and second (6) are added together and the sum divided equally ie. 6½ points for both teams.

- (g) The points awarded to each team in each final are totalled and the winning overall team is the team with the highest number of points.
- (h) If there is equality of points for any of the final overall placings, the tied team which has scored the higher points in the first nominated tie breaker game will be placed ahead of the other tied team/s.  
If there is still equality of points, the points from the second tie breaker game will be used in a similar manner to decide overall placings.

## II. ORGANISING COMMITTEES

### RULE 5: THE NZPCA GAMES COMMITTEE

- (a) The controlling authority for the competition will be the NZPCA.
- (b) **Responsibilities:**
  - (1) Select the games and tie breaker games annually in June.
  - (2) Ensure confirmation of Zone Final dates and venues annually in June.
  - (3) Distribute the rosettes to host Areas.
  - (4) Produce an annual Balance Sheet.
  - (5) Liaise with host Areas.
  - (6) Receive entries from Areas, send a list of the participating team details to host Areas and publish a full set of results on the Games web page.
- (c) **Games:**
  - (1) A balance of games from the following categories should be included in every competition;
    - (i) Fast races.
    - (ii) Slower races, where carrying or picking up and placing articles is a part.

- (iii) Vaulting races.
- (iv) Pairs races.
- (v) Races where all five members may take part.
- (2) No more than half of the six or eight games will include dismounting.
- (d) **Powers of Amendment:** The NZPCA has the right to reduce or increase the number of teams taking part, or to amend any of the rules contained in this booklet if circumstances warrant, and to take any action it may deem necessary in the interest of the competition.

## **RULE 6: AREA COMMITTEE FOR ZONE FINAL**

- (a) The detailed organisation of the Zone Games Final will be undertaken by the Area Committee who may co-opt and/or delegate.
- (b) **Responsibilities:**
  - (1) Attend to all arrangements necessary to ensure a successful competition.
  - (2) Appoint all Officials - Official Steward  
Chief Judge  
Starter  
Time Keepers  
Lane Stewards  
Line Stewards  
Scorer  
Chief Gear Inspector  
Assistant Gear Inspectors  
Commentator  
Publicity Officer  
Arena Party
  - (3) Select a suitable venue; arrange billets or camping facilities, paddocks, public conveniences, sound system, scoring facilities and materials, catering, advertising and publicity. Provide games equipment, and mark and set up the Arena according to the rules.

- (4) Arrange for the attendance of First Aid personnel, have veterinarian and farrier on call.
  - (5) Produce a programme that lists the games, their order, the teams taking part and their team colours, and the draw for the heats of each game.
  - (6) Have on hand a back number for each team and an identifying uniform for Lane Stewards (bibs, white coat etc).
  - (7) Have on hand a set of bathroom scales and a measuring stick.
  - (8) Ensure that the Official Steward's report and a Statement of Income and Expenditure is furnished to NZPCA within five weeks of the Zone Final.
- (c) Provide visiting Areas with format and particulars of the Zone Final at least twelve weeks before the event.

(d) **Format:**

- (1) The arena size should allow for six or seven teams at one time.
- (2) Provided space permits and equipment and personnel are available, up to 7 lanes can be set up and heats run according to the guide below. NB. If 7 lanes are used, an extra 8m should be added for the 7th lane and start/finish and changeover lines lengthened accordingly, i.e. arena width will be 84m.

# of Teams	Heat 1	Heat 2	Heat 3	Heat 4
20	5	5	5	5
20	7	7	6	
19	5	5	5	4
19	7	6	6	
18	6	6	6	
17	6	6	5	

(Oct 2010)

# of Teams	Heat 1	Heat 2	Heat 3	Heat 4
16	6	5	5	
15	5	5	5	
14	7	7		
14	5	5	4	
13	7	6		
12	6	6		

- (3) The final of each game will be made up of the six fastest teams from the heats of that game
- (e) The draw
  - (1) Teams shall be rotated to avoid the same teams running along side each other too often, or being in the same heat together.
  - (2) Avoid teams being in the same lane or in an outside lane more frequently than the others.

### III. ENTRIES FOR THE ZONE FINAL

#### RULE 7: AREA TEAMS - RIDERS AND PONIES

- (a) Each Branch (or club that has no branches) within the Area, may enter teams of 4 or 5 travelling members to the Area Games Trials. If 5 members, each team member must play at least 3 games.
- (b) Riders must be financial members with their Club, Branch, Area and Association (refer to Association Rule 8(b)).
- (c) **Attendance at Rallies:** refer to Rules and regulations for Clubs and Branches - Rule 2:19 Working rallies and Rule 2:20 Attendance at Working Rallies for further details.
- (d) Branches may make up a composite team if they have insufficient

members to meet criteria (b) and (c), at the discretion of the District Commissioner/s concerned.

(Oct.2010)

- (e) Riders are eligible to take part until the end of the season they reach the age of 21 years. The season being from the 1 August until the 31 July the following year.
- (f) A rider weighing over 54kg dressed to compete, may not ride a pony 128cm or under.  
A rider weighing over 60kgs may not ride a pony 133cm or under.  
A rider weighing over 66kgs may not ride a pony 138cm or under.
- (g) A Manager/Coach and an Official helper must accompany each team. The Official helper will be required to lane/line steward or time keep and must be familiar with the rules.
- (h) Teams must remain the same as selected at Area Games Trials. In the event of a pony or rider not being able to compete, refer to Rule 9, Amendment to Entries.
- (i) Mounts must be at least four years old.

#### **RULE 8: ENTRY DETAILS, ENTRY FEES AND CLOSING DATE**

- (a) All team entries to the Zone Final will be made by Areas to NZPCA on the official entry form together with the entry fee no later than 20 working days before the Zone Final.
- (b) The entry fee will be determined annually by NZPCA.
- (c) The Area Secretary, in consultation with the District Commissioner, will certify on the entry form that each rider complies with all rules.

#### **RULE 9: AMENDMENT TO ENTRIES**

Amendments to entries will be accepted after the closing date of entries and up to the start of the competition for a valid reason, on the recommendation of the Branch President and District Commissioner to the Area President and an Area Committee Member, who will jointly approve or decline the team alteration.

NZPCA and the organising committee must both be informed.

#### **RULE 10: TEAM MANAGER/COACH DUTIES AND RESPONSIBILITIES**

- (a) The Team Manager/Coach has the right to call for a Medical or Veterinary Certificate for a competitor or pony within 14 days prior to the Zone Final if, in his opinion, circumstances warrant the same.
- (b) The Team Manager/Coach must inspect accommodation and horse facilities on arrival and departure and ensure that both are left clean and tidy. They must bring to their team members' notice, the responsibility they owe to other peoples' property and to the good name of the NZPCA.

### **IV. AREA GAMES TRIALS**

#### **RULE 11: AREA COMMITTEE RESPONSIBILITIES**

- (a) To select the teams for the Zone Games Finals, trials will be held annually in the 16 Areas.
- (b) Organise the manner in which the teams are selected for the Zone Final based on the current NZPCA TEAM MOUNTED GAMES RULE BOOK.
- (c) The highest placed four or five Branch teams, at the discretion of the Host Area, will qualify for Zone Games Finals.
- (d) Resolve matters relating to Area representation at the Zone Final.
- (e) If the required number of Branch teams per Area cannot be fulfilled, it is that Area's responsibility to inform the Zone Final Host Area, who then has the right to fill any vacancy/s.

#### **RULE 12: DISTRICT COMMISSIONERS RESPONSIBILITIES**

To check the eligibility of Area Trial entrants according to the rules covering entry to Zone Finals (financial/rally/age of riders and mounts, and rider weight/pony height).

## V. ISLAND AND NATIONAL CHAMPIONSHIPS

These rules encompass Island and New Zealand Championships. Refer to the Rules covering Zone Finals for rules not covered in this section.

### RULE 13: THE FORM OF THE COMPETITION

- (a) An Island Championship will be held annually in alternating Islands.
- (b) North Island - each Area may enter one team in total.
- (c) South Island - each Area may enter two or three teams – twelve teams in total.
- (d) Areas are eligible to apply to host a Championship on written application, giving details of venue, pony and rider accommodation, projected income and expenditure.
- (e) In the year prior to the Championship, NZPCA will announce the Host Area in June. The games to be played, including two nominated tie breaker games, will be announced by 31st October.
- (Oct 2010) (f) The NZPCA may issue invitations to Overseas and Island teams, in consultation with the Host Area. Areas must be prepared to host up to two invited teams and provide an arena which caters for heats of seven teams.
- (g) Areas may select a team as they wish. It is suggested that, either the top placed team from the Zone Games Final is selected, a squad is formed, or a selection trial is held. (refer to Area Rule 1:8 Colours, for a list of official colours of each Area)

### RULE 14: OBJECTS

- (a) To provide a level of competition appropriate to advanced and experienced games riders, testing courage, determination and all round skill.
- (b) To provide a competition at which teams may represent their Area at a National level.
- (c) To provide competitive experience at a level which will facilitate preparation for International events.

- (d) To encourage games riders to excel and to continue in the discipline.

### **RULE 15: AREA TEAMS – RIDERS AND PONIES**

- (a) Each team will comprise 5 members.
- (b) In races that require equipment to be held, the fifth rider will do so and must wear full team uniform, including helmet.
- (c) If a reserve/sixth rider is nominated, they must be named on the Entry form and must comply with the Conditions of Entry.
- (d) The reserve/sixth rider must attend the Gear Inspection correctly dressed and mounted, if the pony is on the grounds.
- (e) The reserve/sixth rider (and pony) may replace any team member (and pony), withdrawn due to illness or injury, up until the start of the competition.
- (f) In the event of illness or injury after the start of the competition, resulting in the withdrawal of a team member, the reserve/sixth rider may be used to hold equipment in games where all five riders take part.
- (g) **Attendance at Rallies:** refer to Rules and Regulations for Clubs and Branches - Rule 2:19 Working Rallies and Rule 2:20 **Attendance at Working Rallies** for further details.
- (h) Riders are eligible to take part until the end of the season they reach the age of 21 years. The season being from the 1 August until the 31 July the following year.
- (i) Members must have previously competed in a Zone Final.
- (j) A rider weighing over 54kg dressed to compete, may not ride a pony 128cm or under.  
A rider weighing over 60kgs may not ride a pony 133cm or under.  
A rider weighing over 66kgs may not ride a pony 138cm or under.

### **RULE 16: ENTRIES**

- (a) All team entries will be made by Areas to NZPCA on the official entry form, together with the entry fee, no later than 20 working days before the Championship.

- (b) The entry fee will be set by the NZPCA.
- (c) The Area Secretary, or Chairperson, will certify on the entry form that all rules covering entry to the championship have been complied with.
- (Oct 2010) | (d) Amendments after the closing date, refer to Rule 9.
- (e) Mounts must be at least four years old.

#### **RULE 17: SCORING**

- (a) Teams will be timed in each game, points will accumulate with no finals.
- (b) Points will be awarded on the basis of one point in excess of the number of teams competing e.g. ten teams competing; points will be 11, 10, 9 and 8 etc. One (1) point for elimination, 0 points for disqualification.

#### **RULE 18: NZPCA GAMES COMMITTEE**

- (a) The controlling authority for the Championship will be the NZPCA.
- (b) **Power of Amendment:** The NZPCA has the right to amend the Championship rules if circumstances warrant, and to take any action it may deem necessary in the interest of the Championship.
- (c) The NZPCA will appoint the Official Steward and the Chief Judge. All other Officials will be appointed by the Host Area.

## **V. GENERAL RULES**

#### **RULE 19: DRESS AND SADDLERY INSPECTION**

- (a) Dress and Saddlery will be inspected at least 30 minutes prior to the beginning of the competition and, after being passed, no change will be made. (It is recommended that Areas use the NZPCA Games Gear Inspection Sheets).
- (b) Competitors with unsafe or forbidden gear will replace it and be ready to start on time under penalty of elimination. It is the responsibility of the rider to make sure that gear has been inspected to the satisfaction of the Gear Inspector before starting. Failure to do so may entail elimination.

## **RULE 20: DRESS**

- (a) Team members will wear branch uniform, which must include long sleeves and light coloured jodhpurs. Nothing will be worn over the uniform; any supports or bandages must be underneath.
- (b) If a Branch has more than one team, then one team must wear distinguishing armbands on each arm. The arm bands to be 75mm wide.
- (c) The last rider in each team must wear a band, at least 50mm wide around their helmets and / or a back number. Number 4 rider must be wearing the band / back number at the commencement of each game and failure to do so can incur elimination.
- (d) A properly fitting, securely fastened, correctly maintained helmet meeting the following standards **MUST** be worn - British PAS 015, BSEN 1384, EN 1384, ASNZS 3838 or ASTM F1163 (American Standard).
- (e) If the helmet is lost or the retention harness comes undone, it must be replaced or secured before the rider continues, under penalty of elimination.
- (f) Ear-rings, ear studs and any other exposed jewellery must be removed or taped. Tongue studs must be removed.
- (g) For all Pony Club competitions\*, jodhpur boots (black or brown), long riding boots (being black or brown) or (black boots with brown tops) or two piece boots\* (black or brown) must be worn. If two piece boots are worn, they must be plain dress leather or full grain leather with no added adornment. Both pieces must be matching. \*Refer to Appendix 3 for explanation.

## **RULE 21: SADDLERY AND EQUIPMENT**

### **(a) General**

Whips and spurs are not allowed. Nor should reins or any other equipment be used as a whip.

In events where saddles are not used, neck straps and martingales must also be removed.

The reins must be over the pony's neck when ridden. If necessary, long reins may be knotted, but must be undone at the buckle

end. Reins must not be split at any time.

No item of tack may be used for any purpose, or in any other way than for which it was designed and intended, eg running martingales may not be used as standing martingales.

(Oct 2010)

(b)

### **Bits**

An ordinary snaffle in the manufactured condition, without any additional covering to or on any part. Provided the mouthpiece is smooth, the following bits only are classified as ordinary snaffles:

- (i) Loose ring snaffle
- (ii) Egg butt snaffle
- (iii) D ring snaffle
- (iv) Egg-butt snaffle with cheeks or Full Spoon Cheek snaffle (or loose ringed Tom Thumb)
- (v) Straight bar snaffle; permitted also with mullen mouth and with egg butt rings
- (vi) Double jointed snaffle with rotating middle piece
- (vii) a,b,c Double jointed snaffle provided there is only one mouthpiece  
A Dr Bristol bit, i.e. where the link plate is long, flat and set at an angle, is NOT classed as an ordinary double jointed snaffle
- (viii) Snaffle with upper cheeks only
- (ix) Snaffle with rotating mouthpiece  
Vulcanite, rubber and nylon bits are permissible, provided they comply with the above
- (x) No bitless bridles
- (xi) Thin Bits – bits considered to be excessively thin in the mouthpiece will not be accepted; i.e. minimum diameter 14mm hacks, 10mm ponies.

Refer to Appendix 5 for diagrams of permitted snaffle bits.

(c)

### **Saddles**

Ponies must be turned out with well fitting and properly maintained saddlery, including saddles made on a conventional general purpose tree. If the stirrup bars have safety clips, they should be in the downward position. They should be mounted with leathers, irons and a two buckle girth.

Saddles made without a tree, or those employing a half tree or front arch only, are prohibited. Similarly, racing saddles measuring

less than 40.6cm in length (i.e. from front arch to cantle) and weighing less than 2.8kgs, are not permissible. In events where saddles are not used, neck straps and martingales must also be removed.

Stirrup-irons should be large (but not large enough for the rider's foot to slip right through), and heavy. There should be a minimum clearance of 2cm when the foot is over to one side of the iron. (Toe Stoppers are allowed).

In the interest of safety, the stirrup iron and stirrup leathers must hang free from the bar of the saddle and outside the flap. There must be no other restrictions or attachments of any kind. Where a surcingle is used, it must be ensured that it does not restrict the release of the stirrup leathers from the bars.

(d) **Equipment**

**Bandages and Boots:** If bandages are worn, they must be stitched to the satisfaction of the Gear Inspector. Boots are not required to be stitched or taped.

**Studs:** Studs are not recommended unless absolutely necessary. In adverse weather conditions, the studs illustrated below may be used.

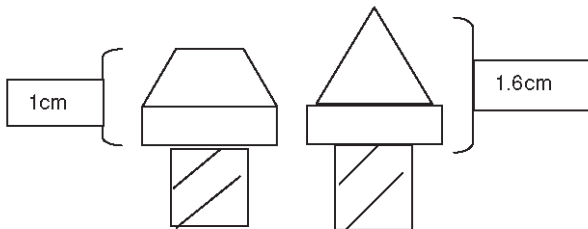

**Martingales:** standing and running martingales are permitted, only one of which may be worn at any one time. Standing martingales may be attached only to a cavesson noseband or the cavesson portion of the noseband of a flash noseband fitted above the bit. Martingales must be secured with a stopper on the junction of the neckstrap and martingale.

**Nosebands:** The only nosebands permitted are cavesson, drop, grackle or flash, only one of which may be worn at any one time. (The kinton and sheepskin nosebands are not permitted).

**Neckstraps:** Monkey straps, neck straps and grass reins are not allowed at Area level and above.

## **RULE 22: LEGAL LIABILITY**

Neither the Organisers nor any person acting on their behalf accept any liability for any loss, damage, accident, injury, or illness to ponies, horses, riders, other persons or property whatsoever.

## **RULE 23: CONCUSSION AND INJURY**

- (a) A rider must not compete or participate mounted in any Pony Club activities for a minimum of 21 days following concussion, without a doctor's written clearance.
- (b) If a rider appears seriously injured, the Official Steward has the discretion to stop the race. When a race is stopped through injury, it will be re-run; the 5th team member may be substituted or, in the case of a team having only four members, one rider will ride twice.

## **RULE 24: TEMPORARY PENS**

The use of unstable, flimsy penning for horses such as electrified tape, string, ropes, or chains is banned at all Pony Club events. Use of this equipment may entail disqualification.

## **RULE 25: OBJECTIONS**

- (a) Only Team Managers are entitled to make requests for information or to lodge objections, which must be made promptly and verbally to the Official Steward.
- (b) No objection will be allowed into the starting, judging or stewarding of any event.
- (c) An objection arising out of a heat or final (other than starting, judging, or stewarding) must be made and decided upon before the start of the next heat or final.

- (d) An objection to the equipment or layout of the arena, must be made not later than half an hour before the start of the competition.
- (e) To prevent disruption during the competition, an objection to the qualification of a rider or a pony must be made as soon as possible and not later than the start of the first game. Should a breach of eligibility subsequently be discovered, then NZPCA may disqualify the offending team. An objection to the weight of a rider may be made at any time during the Competition.
- (f) If the Official Steward cannot give a decision on the day, he may refer it to NZPCA for adjudication.
- (g) An objection arising out of the final result, must be lodged within half an hour of the results being posted and before the awards are made.
- (h) Objections must be made in writing accompanied by \$30, which is forfeited unless the Official Steward decides that there were good and reasonable grounds for the objection. Video evidence will not be considered.

## **RULE 26: DOPING**

### **MOUNTS:**

It is forbidden to administer any prohibited substance to a pony, or to cause one to be administered in any way whatsoever, with the object of influencing the pony's performance at any Pony Club Event, under penalty of disqualification of the Team. (Refer to Appendix 4 - Prohibited Substances)

If, in the course of the competition, it is necessary to treat a pony with a drug that is calming, antitetic, fortifying, or stimulating, the Veterinary Surgeon appointed by the Organising Committee must be informed immediately.

He will verify the expediency of the treatment given and will then make a report to the Official Steward, who will decide whether the pony is to be allowed to continue or to be disqualified. If the treatment has been given for colic only, the Official Veterinary Surgeon decides whether the horse is in a fit state to continue.

## **SPORTS ANTI-DOPING POLICY - RIDERS:**

In adopting the Sports Anti-Doping Policy as laid down by NZPCA, it is the responsibility of each Area to inform their Team Manager and Coach of the policy prior to departure to a national competition. (Refer to the Pony Club Resource Manual or the Resource Page on the NZPCA website for a copy of document PP4.07).

## **RULE 27: GENERAL RULES**

The following rules will apply unless stated to the contrary in the rules of a particular game:

- (a)
  - (i) Any pony that is lame or becomes lame, or has ill-fitting or incorrect saddlery, may be excluded from taking part.
  - (ii) The reins must be over, and not under, the pony's neck.
- (b)
  - (i) Riders must be properly dressed and wearing helmets. Should a helmet come off, or a chin strap become undone, it must be replaced immediately, before resuming the event, under penalty of elimination. Feet need not be in the stirrups all the time.
  - (ii) In all events run up and down the arena, the last rider in each team to go, must wear a band 5cms wide round his helmet and/or a back number. The band/back number must be worn throughout the race and failure to do so will incur elimination.
  - (iii) Organisers will provide team back numbers.
  - (iv) Any team/individual found to have changed, or altered the fitting of, any items of tack/clothing, without permission from the Chief Gear Inspector, may be penalised by disqualification from the competition at the discretion of the Official Steward.
- (c) The signal to start will be at the drop of the starter's flag, when the time will commence.

(Oct 2010)

The starter may order an unruly pony to be held by the Team Manager behind the six metre line.

At the start, the pony's feet must be behind the line until the flag is dropped.

The starter alone is responsible that the start is fair.

If, after dropping the flag, he considers the start to be unfair, he must immediately raise the flag and blow the whistle to recall the riders.

Otherwise, once the riders are away, the start must be accepted as fair and no objections can be considered.

- (d) Except when the rules allow riders to dismount, they must remain mounted (facing forward, legs astride the saddle, or back when saddles are not used) before they reach the changeover or finish line. Should a rider fall off and lose his pony, he must remount and resume the race from the point where he fell off. If necessary, long reins may be knotted, with the buckle undone.
- (e) In all events where a pony is led, it must be held by the rein nearest to the leader. It must not be held by both reins, the bit ring, or any other part of the bridle.
- (f)
  - (i) At a changeover/handover, only the next rider to start is allowed to take up position behind the start line, or changeover line. He must go next and must not be replaced by one of the others for any reason. The remainder of the team must be behind the 6 metre line.
  - (ii) Handovers from one rider to the next must take place behind the line (i.e. the whole of the outgoing rider and his pony must be behind the line until the incoming rider and his pony have crossed it). Should the outgoing rider cross the line too soon, the team will be eliminated unless the rider returns to correct the error.
  - (iii) Deliberate backing off behind the 6 metre line, or any other action by the next rider at a handover which facilitates a "flying" changeover, is not permitted. The Official Steward may eliminate a team who seeks to take this advantage.
  - (iv) A team member may assist another by leading a pony up to the 6m line, but the leader may not cross the 6 metre line.

(Oct 2010)

- (v) At a handover, should the article be dropped, either the incoming or outgoing rider may pick it up. They may dismount to do this or remain mounted. No other rider must handle the item, under penalty of elimination.
- (vi) Only where there are two or more riders from the same team in the play area at a given time, may one rider assist another to mount. Riders may assist each other to mount at any time outside the play area. The play area is defined as the area between the changeover line and the start/finish line.
- (vii) In races where equipment is placed for pick up beyond the changeover line, all four hooves of the pony must cross the line before returning down the arena.
- (g) (i) Loose ponies leaving the arena entail elimination. If a rider deliberately lets go of the pony, e.g. to replace equipment, the team may be eliminated from the event at the discretion of the Official Steward.
- (ii) Only the Lane Stewards of the team involved, the Arena Party, or the team, may help to catch a loose pony, and then only when the pony has left the play area. The team may then continue the race. No other person may enter the arena to catch a loose pony.
- (h) Leaving the arena mounted while the game is in progress will entail elimination.
- (i) (i) No items are to be carried in a rider's mouth, on penalty of elimination. Items may only be carried in a rider's hand.
- (ii) Should a rider drop an article he has to carry, he may dismount to pick it up by hand, after which he must remount to resume the race from where the article was dropped.
- (iii) Should a rider drop an article as he puts it onto or takes it out of a container (or places it on or takes it off a table, post, etc), he may dismount or remain mounted to pick it up. He may then place it where it has to be put whilst dismounted, after which he must remount to resume the event.

- (iv) When correcting an error dismounted, the rider must continue to hold the pony by the rein throughout.
- (v) If any equipment becomes dislodged after the incoming rider has crossed the line, then the outgoing rider must correct it and then return to start their place in the race.
- (j) Should a rider knock over any games equipment used in the game, they must immediately set it up again and replace all the articles that should be in or on it, including their own, even if the article has not been put in or on it yet. They may dismount and do this by hand or remain mounted if they wish. The penalty for infringement is elimination of the team from the game.
- (k) A rider who commits an error during a game must return to correct it, before the handover or finishing, even after crossing the changeover or finishing line, provided he/she has not left the arena or the Chief Judge has not declared the race over.
- (l) In all races in which the riders weave around bending posts the following will apply:
  - (a) The riders may pass the first post on either the right or left. Thereafter they bend alternately to the right and left of the successive posts.
  - (b) The following faults will incur elimination of the team from the game:
    - (i) passing the wrong side of the flag, post or barrel, unless corrected.
    - (ii) failure by the rider concerned to replace a post he has knocked down.
    - (iii) breaking a post. (Definition: A broken post is one which is snapped off and lying on the ground. A post fractured, but not lying on the ground and which has to be replaced at the end of the race, is not deemed to be broken)
- (m) The result of a race will be decided by the time taken when the fourth pony's head crosses the line when ridden, or when the rider crosses the line when dismounted. When ponies finish in pairs, it is the time taken when the head of the second pony crosses the line.

- (n) After crossing the finish line, all riders will pull up to the right. Refer to Appendix 1 regarding positioning of equipment.
- (o) Riders will stay in the arena when they have finished their part in a game and must not ride down the arena until asked to do so. Riders must leave the arena at a walk.
- (p)
  - (i) If a rider or their pony interferes with another team during a game, the offending team may have their placing altered, be eliminated, or in serious cases, disqualified at the discretion of the Official Steward.
  - (ii) If a game is run in lanes, between lanes or bending poles, riders and ponies must remain in their allocated lanes, or risk elimination by the Official Steward.
  - (iii) Races will not be re-run when a team upsets the equipment of another team, but the offending team will be eliminated from the race.
  - (iv) If, for any reason, the Time Keepers cannot decide one or more of the placings in a heat or final, only the teams concerned must run the heat or final again.
- (q) A team will be eliminated for not correcting errors made during a game. A team will be disqualified for serious breaches of the rules.
- (r) Rough or dangerous riding, deliberate interference, unseemly behaviour, abuse of pony, unauthorised changes of tack etc may be penalised by disqualification of the rider or the team from the game concerned, or from the whole competition at the discretion of the Official Steward.
- (s) Unseemly behaviour on the part of riders, team officials, or team supporters, will be reported as soon as possible by the Official Steward to NZPCA and they may be penalised by disqualification of the branch or branches concerned, or club if said club has no branches.
- (t) It is forbidden for anyone other than arena officials to enter the games arena during the competition. However the Team Manager or Coach is allowed in the arena up to the 6m line behind the start/finish line.
- (u) If for any reason a game cannot be run, it will be declared void.

## VI. DUTIES OF THE OFFICIALS

All officials for Zone Finals, shall be appointed by the Host Area Organising Committee, and must be familiar with the rules.

For Island championships, the Official Steward and the Chief Judge shall be appointed by NZPCA. The Host Area will appoint all other officials.

### RULE 28: OFFICIAL STEWARD

- (a) The Official Steward is responsible for ensuring that the whole competition is run in accordance with the rules. His/her authority is final and binding.
- (b) The Official Steward -
- Is responsible for inspecting and approving the layout of the arena and all the equipment.
  - Checks equipment suitability before it is displayed.
  - Conducts the briefing (after the roll call).
  - Ensures that appropriate Risk Management procedures are in place.
  - Ensures that First Aid personnel are in attendance, in the appropriate position and decides when they should be summoned.
  - Briefs the gear inspectors and ensures the gear inspection has been carried out.
  - Supervises the Lane and Line Stewards and may replace a Lane or Line Steward if he considers it necessary.
  - Receives reports on infringements and informs the Chief Judge of his decision.
  - Adjudicates on objections and any unforeseen eventualities.
  - Must carry a whistle in case it is necessary to stop a race.
  - The Official Steward may, on their own initiative, "object" and take action on any matter which comes to his notice.
  - Should have available a height measuring stick and bathroom scales.
  - May declare a race over if it takes too long to complete.
  - Writes a report for NZPCA and sends it to the General Manager within five weeks. The report is to include:

- (i) The general organisation of the event.
- (ii) Any incidents or difficulties.

#### **RULE 29: CHIEF JUDGE**

- (a) The Chief Judge is responsible for ensuring the correct times and order in which the competitors cross the finishing line are recorded.
- (b) The Chief Judge receives reports of eliminations from the Official Steward and, taking these into consideration, gives the results of each heat and final to the scorer and the commentator.
- (c) Equipment Required: Sheets for recording times and pencils.

#### **RULE 30: CHIEF GEAR INSPECTOR**

- (a) It is the responsibility of the Chief Gear Inspector to brief the Gear Inspectors.
- (b) The Chief Gear Inspector must ensure that each competitor's gear is inspected and complies with the rules.
- (c) Clothing and equipment will not be changed after inspection without reference to the Chief Gear Inspector.
- (d) Equipment required: gear inspection sheets, pencils, list of team competitors.

#### **RULE 31: STARTER**

- (a) The Starter is responsible for starting each game - refer Rule 27(c)
- (b) The Starter's position is in line with the first line of bending posts. He must ensure he can be clearly seen by all the competitors on the start line.
- (c) In the event of a false start, the starter will immediately blow the whistle and raise the flag to recall the teams.
- (d) Should any pony become unruly at the start, the Starter may order it to be held by the Lane Steward of the team in question, behind the six metre line.
- (e) (i) The Starter should raise the flag to call the riders to the line.

- (ii) Holding the flag upright whilst riders settle, he should have the whistle ready in the other hand.
  - (iii) When he is satisfied that the riders are settled, the flag is lowered to indicate the start of the race.
- (e) Equipment required: starting flag, whistle and a raised platform for standing on.

### **RULE 32: TIME KEEPERS**

- (a) The Time Keepers are responsible for timing each heat and final in their lane.
- (b) Time commences at the drop of the Starter's flag and concludes when the fourth pony's head crosses the line when ridden, or the rider crosses the line when dismounted. When ponies finish in pairs, it is the time taken when the head of the second pony crosses the line.
- (c) Equipment required: stop watches (spares).

### **RULE 33: LANE STEWARDS**

- (a) There will be one Lane Steward per lane, positioned behind the Changeover line and in line with the lane they are judging.
- (b) There will be one Line Steward positioned at the side of the arena at each end of the Start/finish, Centre and Changeover lines.
- (c) Lane and Line Stewards must have a thorough knowledge of the rules and details of each game they are to steward and must attend the briefing.
- (d) Lane and Line Stewards must be identifiable (see rule6 (b)(6) and, where possible, Lane Stewards will not be required to act on a lane in which their team is participating.
- (e) Lane and Line Stewards signals are for the guidance of the Official Steward and not for the competitors.
- (f) Infringements of the rules must be signalled:
  - (i) at once by Lane Stewards by raising an arm or flag, keeping it up until the end of the race, unless the infringement is corrected, when the arm is immediately lowered.

- (ii) at the end of the race by Line Stewards by raising an arm or flag for the attention of the Official Steward, unless the infringement is corrected.
- (g) In the case of obstruction by any team, the Lane Steward of the team causing the obstruction does NOT signal until the end of the race. At that time their arm is raised for the attention of the Official Steward who will then adjudicate. The Lane Steward of the team obstructed does NOT signal.
- (h) Lane and Line Stewards must not call instructions to any competitor, but they must answer competitor's questions (as briefly as possible).
- (i) If a team's equipment is upset by another team, the Lane Steward of the team upset will quickly enter the lane to correct it, if this is possible.
- (j) Close concentration is required by Lane Stewards and Line Stewards, who must ensure they are not distracted, even by a bad upset in a lane.
- (k) Start and Changeover Line Stewards must ensure that only the next rider to go takes up the position at the start or change over line. The others must remain behind the six metre line.
- (l) If a pony runs loose, only the Lane Steward of the team concerned should endeavour to catch it but only after it has left the play area. (The Arena party may also help after the pony has left the play area). Line Stewards should continue to concentrate on their line.
- (m) Lane Stewards are not responsible for the position of the ponies at the start.
- (n) If an unruly pony has to be held, the Team Manager or Coach (whichever is in the Arena) will do so, and must be behind the six metre line.
- (o) Lane Stewards at the changeover line should ensure that competitors do not ride back down the arena until the game is declared over.
- (p) Stewards will report to the Official Steward any person who questions their decisions, is abusive, or obstructs their duties in any way whatsoever.

### **RULE 34: SCORER**

- (a) The Scorer keeps the scores, informs the Commentator of the current positions and marks up the scoreboard.
- (b) Results of heats and finals must be posted as soon as possible after the completion of each game. current positions and marks up the scoreboard.
- (c) Provides the webmaster a complete set of results for the website, immediately following the event.

(Oct-2010)

### **RULE 35: COMMENTATOR**

- (a) The Commentator calls in the teams for each heat and final and indicates their lanes for each game.
- (b) The Commentator announces the results of each heat and final and gives aggregate scores of the teams after each final.
- (c) Instructs teams to move down the arena or to leave the arena as per the instructions of the Official Steward.

(Oct-2010)

### **RULE 36: ARENA PARTY**

- (a) The Arena Party puts up and issues equipment and ensures that everything is ready for each event and removes the equipment when it is no longer required.
- (b) Catches any loose pony once it has left the play area.

## NEW ZEALAND PONY CLUBS TEAM MOUNTED GAMES

- |                          |                             |
|--------------------------|-----------------------------|
| 1. Anti Litter race      | 29. Pony Club race          |
| 2. Aunt Sally race       | 30. Pony Express race       |
| 3. Ball and Bucket race  | 31. Postman's Chase         |
| 4. Ball and Cone race    | 32. Potato Picking Scramble |
| 5. Ball and Racquet race | 33. Potato race             |
| 6. Balloon Bursting race | 34. Pyramid race            |
| 7. Bending race          | 35. Ring race               |
| 8. Bottle race           | 36. Rope race               |
| 9. Canadian race         | 37. Run and Ride            |
| 10. Carton Race          | 38. Sack race               |
| 11. Egg and Racquet race | 39. Sharp Shooters race     |
| 12. Egg and Spoon race   | 40. Stepping Stone Dash     |
| 13. Fishing race         | 41. Sword race              |
| 14. Five Flag race       | 42. Tack Shop race          |
| 15. Five Mug race        | 43. Three Legged Sack race  |
| 16. Grooms Stakes        | 44. Three Mug race          |
| 17. Hi Lo race           | 45. Two Flag race           |
| 18. Housewife's Scurry   | 46. Windsor Castle race     |
| 19. Hurdle race          |                             |
| 20. Knickerbocker Glory  |                             |
| 21. Litter race          |                             |
| 22. Milk race            |                             |
| 23. Motor Tyre race      |                             |
| 24. Mug Shuffle          |                             |
| 25. Newspaper race       |                             |
| 26. Nine Ring race       |                             |
| 27. Old Sock race        |                             |
| 28. Pony Club Pole race  |                             |

### NOT CONSIDERED TEAM RELAY GAMES:

- 47. Barrel race
- 48. Keyhole race

# 1. ANTI LITTER RACE

Eight litter cartons will be placed in a row, 3m beyond both the start/finish line and the changeover line, the open ends facing toward the 6m line.

A litter bin will be placed on the centre line.

1. Numbers 1 and 2 will start behind the start/finish line. No.'s 3 and 4 will start behind the changeover line.
2. On the start signal, riders No.1 and 2, each carrying a cane, will ride to the litter behind the changeover line. They will each pick up one piece of litter with their cane, then drop it into the bin on the centre line and continue in this way until all eight pieces of litter have been collected.
3. They will then hand over the canes to No.'s 3 and 4, behind the changeover line, who will complete the race in the same way.
4. The second pair may not start until both No.'s 1 and 2 have crossed the changeover line.
5. The winning team will be the one whose final pair of riders crosses the finish line first, correctly mounted and carrying their canes.
6. Either rider of the pair concerned, can pick up dropped litter, wherever it may be. Riders do not need to collect the same number of litter cartons.
7. Should any litter fall off the cane, the rider must pick it up again while mounted, except when the litter misses the bin, in which case the rider may dismount and put the litter in the bin by hand.
8. Should a bin be knocked over, the rider concerned must immediately set it up again. He may dismount to do so and may put the litter back into the bin by hand. The other rider of the pair may not drop any litter into the bin whilst the bin is being set up and the dropped litter replaced.
9. Riders must remain mounted and must not hold the litter by hand when picking it up, carrying it on the cane, or dropping it into the bin.
10. If the litter is pierced and slides down the cane, it may be allowed to rest against the hand.
11. If the litter becomes jammed onto the cane, it may be loosened by hand before being dropped into the bin from the cane.

## EQUIPMENT PER LANE

- 16 cylindrical 1 litre plastic detergent bottles with the neck cut off.
- 1 plastic litter bin, 45-76cm high.
- 2 wooden or bamboo canes, 1.2m long, each end bound with tape.

## 2. AUNT SALLY RACE

A bale will be placed with its' back edge 3m beyond the changeover line.

Evenly spaced on the bale, will be stood six two litre milk containers.

A second bale will be placed directly behind the changeover line, on which will be twelve tennis balls.

The Team Manager will stand in front of the changeover line.

1. All four riders will start behind the start/finish line.
2. On the start signal, No.1 will ride down the arena, dismount and hand his pony to the Team Manager.
3. The rider will throw a ball/s to knock over one container, then remount and return to the start.
4. No.'s 2, 3 and 4 complete the race in the same way.
5. The winning team will be the one whose No. 4 is first across the finish line, correctly mounted.
6. Each rider must knock one container over onto its' side. It need not fall off the bale.
7. There is no penalty for knocking over more than one container, provided there is one container still in place for No. 4.
8. The whole of the rider's feet must remain in front of the changeover line.
9. The Team Manager must be holding the pony while the rider is throwing the balls and may not assist the rider to mount.
10. The Team Manager, or an extra Steward, may collect up balls between riders.

### EQUIPMENT PER LANE

- 2 bales of straw or hay.
- 12 tennis balls.
- 6 x 2 litre plastic milk containers, slightly weighted (with water).

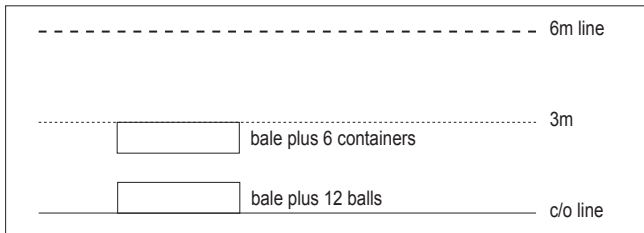

### 3. BALL AND BUCKET RACE

Four tennis balls will be placed inside a 50cm marked circle 3m beyond the changeover line.

A bucket will be placed on the centre line.

1. All four riders will start behind the start/finish line.
2. On the start signal, No.1, carrying a ball, will race to his team's bucket and drop the ball into it. He will continue to the changeover line, dismount to pick up another ball, remount and return to the start, handing it over to No.2.
3. No.'s 2, 3 and 4 will continue in the same way. No. 4 will drop the 5th ball into the bucket on the way back.
4. The winning team will be the one whose No.4 is first across the finish line, correctly mounted.
5. Riders must be mounted when dropping the balls into the bucket. If a ball misses the bucket, the rider may dismount to collect it and can put it into the bucket while dismounted but, must remount to continue.
6. Should a bucket be knocked over, the rider concerned must set it up again and may replace any spilled balls while dismounted.
7. Lane Stewards should replace balls knocked out of the circle when safe to do so.

#### EQUIPMENT PER LANE

- 5 tennis balls.
- 1 10 litre plastic bucket.

## 4. BALL AND CONE RACE

A road cone will be placed 14m from both the start line and the changeover line.  
A tennis ball will be placed on the cone nearest the changeover line.

1. Numbers 1 and 3 will start behind the start/finish line. No.'s 2 and 4 will start behind the changeover line.
2. On the start signal, No.1, carrying a tennis ball, will ride to the nearest cone and place the ball onto it, continue to the next cone, collect the ball, then hand it over to No. 2.
3. No.'s 2, 3 and 4 continue in the same way.
4. The winning team will be the one whose No. 4 is first across the finish line, correctly mounted and carrying a tennis ball.
5. If a cone is knocked over, or a ball dropped, the rider must reset it or pick it up again.
6. If a rider drops a ball while attempting to place it on a cone, he may dismount and place it from the ground, but must remount to continue to the next cone.

### EQUIPMENT PER LANE

- 2 road cones, 45cm high.
- 2 tennis balls.

## **5. BALL AND RACQUET RACE**

A line of three bending poles will be placed 9m apart, the first pole 14m from the start line.

A container holding 3 spare balls will be fixed to the centre pole.

1. All four riders will start at the start/finish line.
2. On the start signal, No.1, carrying a racquet on which is balanced a ball, will bend up and back through the poles, then hand over the racquet to No. 2.
3. No.'s 2, 3 and 4 will continue in the same way.
4. The winning team will be the one whose No. 4 is first across the finish line, correctly mounted, balancing the ball on the racquet.
5. Dropped balls can either be picked up, or another ball collected from the container. The ball need not be placed on the racquet until the rider returns to the point at which the error occurred.
6. Balls dropped during a handover, may be picked up and placed on the racquet by the incoming rider, while he is still dismounted.
7. Riders' hands must remain behind the tape on the handle of the racquet.

### **EQUIPMENT PER LANE**

- 3 bending poles, 1.2-1.5m high.
- 1 wooden or plastic tennis racquet with tape halfway down the handle.
- 4 tennis balls.
- 1 plastic or metal container, approx. 20cm square/diameter, 5 cm deep, fixed to the top or side of the centre pole.

## 6. BALLOON BURSTING RACE

Six balloons, attached as below, will be placed in a straight line up and down the arena, across the centre line.

1. Numbers 1 and 3 will start behind the start/finish line. No.'s 2 and 4 will start behind the changeover line.
2. On the start signal, No.1, carrying a lance, will ride down the arena, bursting a balloon on the way, then hand over the lance to No. 2.
3. No.'s 2, 3 and 4 continue in the same way.
4. The winning team will be the one whose No. 4 is first across the finish line, correctly mounted and carrying the lance.
5. Riders may make more than one attempt to burst a balloon, which may be done with either end of the lance.
6. There will be no penalty if a rider bursts more than one balloon, provided there is one balloon still in place for No. 4.
7. If a rider fails to burst a balloon, the team will be eliminated.

### EQUIPMENT PER LANE

- 6 inflated balloons spaced 50cm apart, attached to .....
- 1 wooden board, canvas or carpet strip, approx. 3m length.
- 1 wooden or bamboo lance, 1.2m long, with a drawing pin taped securely onto one end.

## **7. BENDING RACE**

A line of five bending poles will be placed 9m apart, the first pole 14m from the start line.

1. All four riders will start behind the start/finish line.
2. On the start signal, No.1, carrying a baton, will bend up and back through the poles then hand over the baton to No. 2.
3. No.'s 2, 3 and 4 will continue in the same way.
4. The winning team will be the one whose No. 4 is first across the finish line, correctly mounted and carrying the baton.
5. Riders may pass either side of the first pole.
6. Poles knocked completely down to the ground must be replaced by the rider concerned.
7. Riders may continue if a pole is only partially knocked over, provided they can do so correctly.
8. Poles completely broken off will result in the elimination of the team.
9. Lane Stewards will not signal unless the pole is broken or lying flat on the ground.

### **EQUIPMENT PER LANE**

- 5 bending poles, 1.2-1.5m high.
- 1 baton, 30cm long, 25mm diameter.

## 8. BOTTLE RACE

An upturned litter bin will be placed on the centre line and another placed 3m beyond the changeover line.

A bottle will be placed on the changeover end bin.

1. All four riders will start behind the start/finish line.
2. On the start signal, No.1, carrying a bottle, will ride to put it down on the centre line bin, continue to pick up the bottle from the changeover end bin and return to the start, to hand it over to No. 2.
3. No. 2 will ride to the changeover end, put the bottle down on the bin, then pick up the bottle from the centre line bin and return to the start to hand it over to No. 3.
4. No.'s 3 and 4 will continue in the same way.
5. The winning team will be the one whose No. 4 is first across the finish line, correctly mounted and carrying a bottle.
6. The bottle must stand upright on the bin. If it falls or is dropped, or the bin is knocked over, the rider must reset the equipment and may do so dismounted.

### EQUIPMENT PER LANE

- 2 cylindrical 1 litre plastic bottles, with flat bottoms and straight sides, such as detergent bottles, lightly weighted with sand.
- 2 drums or upturned litter bins, 45-76cm high. A circular ply top may be fixed to the upturned litter bin.

(Oct 2010)

## 9. CANADIAN RACE

Four bending poles will be placed 9m apart, the first pole 14m from the start line.

Two road cones will be placed 1.8m apart on the changeover line.

Four balls will be placed in a row across the arena, 0.3m apart, 7m from the changeover line.

1. All four riders will start behind the start/finish line.
2. On the start signal, No. 1, carrying a hockey stick, will bend through the poles and hit one ball. He must continue to hit the same ball until it goes through the cones, then bend back through the poles to hand over the hockey stick to No. 2.
3. No.'s 2, 3 and 4 continue in the same way.
4. The winning team will be the one whose No.4 is first across the finish line, correctly mounted and carrying the hockey stick.
5. If a pony kicks a ball through the goal, that ball must be brought back over the goal line. The ball does not have to go back to its' original position.
6. Lane Stewards should replace balls knocked out of position when safe to do so.

### EQUIPMENT PER LANE

- 4 bending poles, 1.2-1.5m high.
- 2 road cones.
- 4 balls.
- 1 plastic or light wooden hockey stick.

## 10. CARTON RACE

A line of 4 bending poles will be placed 9m apart, the first pole 14m from the start

line.

A carton will be placed on each pole.

A bucket will be placed 3m behind the changeover line in line with the bending poles.

1. All four riders will start behind the start/finish line.
2. On the start signal, No 1 will race to collect a carton from any pole and continue to drop it into the bucket. He will then return across the start/finish line.
3. No's 2, 3 and 4 continue in the same way.
4. The winning team will be the one whose No 4 is first across the finish line correctly mounted.
5. Cartons dropped, bending poles or buckets knocked over must be picked up or re-set by the rider concerned, who may dismount to do so.
6. Riders do not have to bend through the poles

### **EQUIPMENT PER LANE**

- 4 bending poles, 1.2-1.5m high
- 4 cartons, cylindrical 1 litre plastic detergent bottles with the necks cut off.
- 1 10 litre plastic bucket

## 11. EGG AND RACQUET RACE

A line of three bending poles will be placed 9m apart, the first pole 14m from the start line.

On the centre pole will be a container holding four spare eggs.

1. All four riders will start behind the start/finish line.
2. On the start signal, No. 1, carrying a racquet on which is placed an egg, will bend up and down through the poles, return to the start and hand over the racquet to No. 2.
3. No.'s 2, 3 and 4 will continue in the same way.
4. The winning team will be the one whose No. 4 is first across the finish line, correctly mounted and balancing the egg on the racquet.
5. A dropped egg must be picked up, or another collected from the container, and the race resumed from the point where the error occurred. This is the only time the egg may be touched by hand, unless dropped during the handover.
6. Should the egg be dropped during the handover, the rider may dismount to collect it and may place it on the racquet for the next rider while he is still dismounted.
7. Riders' hands must remain behind the tape on the handle of the racquet.

### EQUIPMENT PER LANE

- 3 bending poles, 1.2-1.5m high.
- 1 wooden or plastic tennis racquet with tape halfway down the handle.
- 1 wooden, pottery, or clay egg, or golf ball.
- 1 plastic or metal container, approx. 20cm square/diameter, 5 cm deep, fixed to the top or side of the centre pole.

## 12. EGG AND SPOON RACE

A line of three bending poles will be placed 9m apart, the first pole 14m from the start line.

On the centre pole will be a container holding four spare eggs.

1. All four riders will start behind the start/finish line.
2. On the start signal, rider No.1, balancing an egg on a spoon, will bend up and back through the poles, then hand over the egg and spoon to No. 2.
3. No.'s 2, 3 and 4 will continue in the same way.
4. The winning team will be the one whose No.4 rider is first across the finish line, correctly mounted, balancing the egg on the spoon .
5. A dropped egg must be picked up, or another collected from the container on the centre pole. This is the only time that an egg may be touched by hand, unless dropped during the handover.
6. The rider must resume the race at the point where the egg was dropped and the egg need not be placed on the spoon until that point is reached.
7. Should the egg be dropped during the handover, the incoming rider may dismount and put the egg onto the spoon from the ground.
8. Riders' hands must remain behind the tape on the handle of the spoon.

### EQUIPMENT PER LANE

- 3 bending poles 1.2-1.5m high.
- 1 plastic or metal container, approx. 20cm square/diameter, 5 cm deep, fixed to the top or side of the centre pole.
- 1 wooden, pottery, or clay eggs, or golf ball.
- 1 metal spoon, with coloured tape bound around the handle 2.5cm from the bowl of the spoon.

## 13. FISHING RACE

Four fish will be placed in a litter bin on the centre line, upright, with rings uppermost.

The Team Manager will hold the stand, 3m beyond the changeover line.

1. All four riders will start behind the start/finish line.
2. On the start signal, No.1, carrying the rod, will hook one of the fish from the bin, ride across the changeover line, where the Team Manager will remove the fish and hang it on a hook.
3. The Team Manager will raise a hand to indicate to the Lane Steward that the fish is hung correctly and the rider will then return to the start to hand over the rod to No. 2.
4. No.'s 2, 3 and 4 will continue in the same way.
5. The winning team will be the one whose No. 4 is first across the finish line, correctly mounted and carrying the rod, with the four fish hung correctly on the stand.
6. Dropped fish may be retrieved either mounted or dismounted, but must be picked up with the hook.
7. If a fish is dropped when handing over to the Team Manager, the Team Manager may pick it up and put it on the stand.
8. If the rod is dropped while the fish is being removed by the Team Manager, the rider must pick it up.
9. If the bin is knocked over, it must be reset and any spilled fish may be replaced by hand.
10. 10.Riders may not recross the changeover line until their fish has been correctly hung on the stand.
11. The stand may be held with the hooks facing either way but it may NOT be turned during the game.

### EQUIPMENT PER LANE

- 4 fish, 19cm across the widest part of the body, 40cm long, made of 12-15mm ply, each with a ring through the nose, approx 3cm diameter.
- 1 wooden T shaped stand, 1.2m high, with a 90cm crosspiece, with 4 equally spaced cup hooks on the underside.
- 1 litter bin, 45-76cm high.
- 1 fishing rod, 1.2m long, made of 12-15mm dowelling, with a cup hook screwed or taped to one end.

## 14. FIVE FLAG RACE

A flag holder will be placed on the centre line and another 3m beyond the changeover line.

Four flags will be placed in the centre line holder.

1. All four riders will start behind the start/finish line.
2. On the start signal, No.1, carrying a flag, will ride to the changeover end and put the flag in the holder, then collect a flag from the centre line holder and return to the start, handing it over to No. 2.
3. No.'s 2, 3 and 4 continue in the same way.
4. The winning team will be the one whose No. 4 is first across the finish line, correctly mounted and carrying a flag, with four flags in the holder at the changeover end.
5. If a flag holder is knocked over, it must be reset and any flags tipped out must be replaced. The rider may dismount to do so.
6. Should a rider take more than one flag from the holder, he must replace the surplus and may dismount to do so.
7. Should a flag come off the cane, the cane may be used to complete the race.

### EQUIPMENT PER LANE

- 2 flag cones, road cones, 45cm high with tops cut off to leave a 10cm diameter hole
- 5 wooden or bamboo canes, 1.2m long, each with a cloth or plastic flag, 25cm square or 25cm triangular, the other end bound with tape.

## 15. FIVE MUG RACE

A line of four bending poles will be placed 9m apart, the first pole 14m from the start.

An upturned litter bin will be placed 3m behind the changeover line.

Four mugs will be placed inverted on the bin.

1. All four riders will start behind the start/finish line.
2. On the start signal, No.1, carrying a mug, will put it inverted on one of the poles, continue to the changeover end, collect another mug and return to the start, handing it over to No.2.
3. No's 2, 3 and 4 will continue in the same way.
4. The winning team will be the one whose No. 4 is first across the finish line, correctly mounted, carrying the fifth mug, with a mug on each of the four poles.
5. Riders need not BEND through the poles, but may ride between them to place the mug.
6. Dropped and fallen mugs must be picked up by the rider concerned and may be placed dismounted.
7. Mugs knocked off the bin must always be replaced inverted.
8. If a pole is broken, the team will be eliminated.

### EQUIPMENT PER LANE

- 4 bending poles, 1.2-1.5m high.
- 1 drum or upturned litter bin, 45-76cm high. A circular ply top may be fixed to the upturned litter bin.
- 5 metal or plastic mugs.

## 16. GROOMS STAKES

A line of four bending poles will be placed 9m apart, the first pole 14m from the start line.

1. No.1 will line up mounted behind the start/finish line, leading No. 2's pony.  
No. 3 will be dismounted behind the 6m line holding No. 4's pony.  
No. 2 will be dismounted behind the changeover line holding No.3's pony.  
No. 4 will stand behind the 6m line at the changeover end.
2. On the start signal, No.1 will bend through the poles, leading No. 2's pony.  
Once across the changeover line, No. 1 will hand the pony to No. 2.
3. No. 2 will then mount and bend through the poles, leading No.3's pony.
4. After No. 2 has started, No.1 will dismount and hand his pony to No. 4.
5. Once across the start line, No. 2 will hand his pony to No. 3, who will mount and bend through the poles, leading No. 4's pony.
6. No. 4 will mount and bend through the poles leading No.1's pony.
7. The winning team will be the one whose No. 4 is first across the finish line, correctly mounted and leading No.1's pony.
8. Should a rider let go of the led pony, he must resume the race from the point where the error occurred.
9. Having completed a changeover, the incoming rider may not recross the line to give a lead or encouragement.
10. Ponies must be led by the nearest rein. No other part of the bridle may be held at any time.

### EQUIPMENT PER LANE

- 4 bending poles, 1.2-1.5m high.

## 17. HI LO RACE

A line of four road cones, each with a tennis ball on top, will be placed 9m apart, the first cone 14m from the start line.

A pole/post with a net attached, will be fixed to the ground 3m beyond the changeover line.

1. All four riders will start behind the start/finish line.
2. On the start signal, No.1, carrying a tennis ball, will ride up the arena and place the ball in the net, then return to the start, collecting a ball from one of the cones and handing it over to No. 2.
3. No.'s 2, 3 and 4 will continue in the same way.
4. The winning team will be the one whose No. 4 is first across the finish line, correctly mounted and carrying a ball.
5. If a ball falls to the ground while being picked up from a cone, or if a cone is knocked over, the rider must correct the error and may dismount to do so.
6. Balls dropped while being put into the net, may be picked up either mounted or dismounted and may then be put into the net from the ground.
7. A rider may place the ball into the net either directly in front of it or by passing around the pole/post.

### EQUIPMENT PER LANE

- 4 road cones, 45cm high.
- 5 tennis balls.
- 1 pole/post, 2m high, fixed to the ground. This may have a figure attached.
- 1 20cm ring and net fixed to the top of the pole.

## 18. HOUSEWIFE'S SCURRY

An upturned litter bin will be placed 3m beyond the changeover line, with a container on top holding 1 apple, 1 orange, 1 carrot, 1 onion.

A bucket will be placed on the centre line.

1. All four riders will start behind the start/finish line.
2. On the start signal, No.1, carrying a potato, will ride to his team's bucket and drop the potato into it, continue to the changeover end, pick up the apple and return to the start, handing it over to No. 2.
3. No.'s 2, 3 and 4 will continue in the same way, with No. 2 collecting the orange and No. 3 the carrot.
4. No. 4 will collect the onion and drop it into the bucket on his way to the finish.
5. The winning team will be the one whose No. 4 is first across the finish line, correctly mounted and with all items dropped into the bucket in the correct order.
6. Riders must be mounted when dropping the items into the bucket. If an item misses the bucket, the rider may dismount to collect it and can put it into the bucket while dismounted but, must remount to continue.
7. Should a bucket be knocked over, it must be reset and any spilled items replaced. The rider may dismount to do so.
8. Items must be collected in the correct order.

### EQUIPMENT PER LANE

- 1 apple, 1 orange, 1 carrot, 1 onion, 1 potato.
- 1 drum or upturned litter bin, 45-76cm high. A circular ply top may be fixed to the upturned litter bin.
- 1 2 litre ice cream container for vegetables.
- 1 10 litre plastic bucket.

## 19. HURDLE RACE

A line of four hurdles will be placed across the centre line, 1.8m apart, alternating small, high, small, high from the start end.

An inverted mug will be placed on the top of each large hurdle.

1. Numbers 1 and 2 will start side by side behind the start/finish line, with No. 4 behind the 6m line. No. 3 will start behind the changeover line.
2. On the start signal, No.'s 1 and 2 will ride to the hurdles, No.1 will dismount and hand his pony to No. 2.
3. No.1 will step over the first hurdle, crawl under the second hurdle, step over the third and under the fourth,
4. No.1 will then remount and both riders will continue across the changeover line, where No.1 will wait.
5. No. 2 will then turn and return with No. 3, No. 2 dismounting and negotiating the hurdles.
6. No.'s 2 and 3 will then return to the start line where No. 2 will drop out.
7. No. 3 will turn and continue in the same way with No. 4, with No. 3 negotiating the hurdles.
8. No.'s 4 and 1 will continue in the same way with No. 4 negotiating the hurdles.
9. The winning team will be the one whose final pair of No.'s 1 and 4 is first across the finish line, correctly mounted.
10. At each changeover, the next rider must remain behind the line until the incoming riders have both crossed it.
11. The rider who is to hold the pony at the hurdles, may grasp the rein before, or as they ride down the arena.
12. The rider who is to negotiate the hurdles may dismount at any point after crossing the line.
13. If a hurdle is knocked over, or a mug knocked off, they must be reset and the rider must re-negotiate all the hurdles.

### EQUIPMENT PER LANE

- 2 hurdles 60cm high x 70cm wide (internal dimension), each with a 15cmx15cm piece of plywood fixed to the middle of the top rail.
- 2 hurdles 30cm high x 70cm wide (external dimension).
- 2 metal or plastic mugs.

## 20. KNICKERBOCKER GLORY

A line of five bending poles will be placed 9m apart, the first pole 14m from the start line.

1. All four riders will start behind the start/finish line.
2. On the start signal, No. 1, carrying a cone on which is balanced a ball, will bend up and back through the poles, to hand over the cone to No. 2.
3. No.'s 2, 3 and 4 continue in the same way.
4. The winning team will be the one whose No. 4 is first across the finish line, correctly mounted, with the ball balanced on the cone.
5. A dropped ball must be picked up and the race resumed from the point where the error occurred. This is the only time the ball may be touched by hand, unless dropped during the handover.
6. If the ball falls during the handover, the rider concerned must retrieve it, even if it has rolled into the play area. He may then place it on the cone for the next rider while dismounted.

### EQUIPMENT PER LANE

- 5 bending poles, 1.2-1.5m high.
- 1 'ice cream cone'.
- 1 plastic or tennis ball.

## 21. LITTER RACE

Six identical pieces of litter will be placed side by side 3m beyond the changeover line.

They will be arranged in a straight line, with the open ends facing away from the start.

1. All four riders will start behind the start/finish line.
2. On the start signal, No.1, carrying a cane, will ride up the arena, across the changeover line and pick up a piece of litter with the cane. He will then return to the start, dumping the litter into the bin on the way, and hand over the cane to No. 2.
3. No.'s 2, 3 and 4 will continue in the same way.
4. The winning team will be the one whose No. 4 is first across the finish line, correctly mounted and carrying the cane.
5. Riders must remain mounted while picking up the litter and must not touch it by hand when picking it up, carrying it, or dumping it.
6. A rider may pick up any piece of litter from his circle, but after crossing the line, must continue with the same piece of litter.
7. Riders must be mounted when dumping the litter into the bin. If a piece of litter misses the bin, the rider may dismount to collect it and can put it into the bin by hand while dismounted but, must remount to continue.
8. If the bin is knocked over, it must be reset and the rider may dismount to do so. He may replace any spilled litter by hand, including his own, even if it had not been dumped into the bin.
9. If litter becomes hollow and slides down the cane, it may be allowed to rest against the hand.
10. If litter becomes jammed on the cane, it may be loosened by hand before being dropped into the bin from the cane.

### EQUIPMENT PER LANE

- 6 cylindrical 1 litre plastic detergent bottles with the necks cut off.
- 1 litter bin, 45-76cm high.
- 1 wooden or bamboo cane, 1.2m long, the ends bound with tape.

## 22. MILK RACE

A 'cow' will be placed on the centre line facing toward the start.

Four plastic milk bottles will be placed under the cow.

Two milk crates will be stacked 3m behind the changeover line.

Three paper feed sacks will be placed upright around the crates.

1. All four riders will start behind the start/finish line.
2. On the start signal, No.1, carrying a paper feed sack, will ride to the cow, dismount and place the sack in front of it. He will then collect a milk bottle, remount and continue to the changeover end to put it into the crate, collect a feed sack and return to the start, handing it over to No. 2.
3. No.'s 2, 3 and 4 continue in the same way.
4. The winning team will be the one whose No.4 is first across the finish line, correctly mounted and carrying the last sack.

### EQUIPMENT PER LANE

- 1 plywood cow.
- 2 milk bottle crates.
- 4 plastic 1 litre milk bottles.
- 4 feed sacks, 25kg capacity, partly filled with straw or hay.

## 23. MOTOR TYRE RACE

A motorcycle tyre will be placed on the centre line.

1. Numbers 1 and 2 will line up side by side behind the start/finish line. No. 4 will wait behind them. No. 3 will start behind the changeover line.
2. On the start signal, No.'s 1 and 2 will ride to the tyre. No.1 will dismount, hand the pony to No. 2 and go through the tyre, then remount. Both riders will continue to the changeover line where No.1 will wait.
3. After crossing the line, No. 2 will turn and return to the tyre with No. 3. No. 2 will dismount, hand the pony to No. 3, go through the tyre, then remount. Both riders will continue to the start line, where No. 2 will drop out.
4. No.'s 3 and 4 will continue, with No. 3 going through the tyre. No. 3 will then drop out.
5. No.'s 4 and 1 will continue, with No. 4 going through the tyre.
6. The winning team will be the one whose final pair of No.'s 4 and 1 is first across the finish line, correctly mounted.
7. At changeovers, the next to go must remain behind the line until both ponies have crossed it.
8. The rider who is to hold the pony at the tyre, may grasp the nearest rein before, or as they ride down the arena. His partner may not touch the tyre until the pony is handed over.
9. The rider dismounting may do so at any point after crossing the line.

### EQUIPMENT PER LANE

- 1 motorcycle tyre, 40-48cm internal diameter.

## 24. MUG SHUFFLE

A line of 4 bending poles will be placed 9m apart, the first pole 14m from the start line.

A mug will be placed on pole 1 and another on pole 3.

1. Numbers 1 and 3 will start behind the start/finish line. No's 2 and 4 will start behind the changeover line.
2. On the start signal, No 1 will race to pole 1, collect the mug and place it on pole 2. He will continue to pole 3 and move the mug to pole 4, then continue across the changeover line.
3. No 2 will ride to pole 4, collect the mug and place it on pole 3. He will then remove the mug from pole 2 and place it on pole 1 and continue across the start/finish line.
4. No.'s 3 and 4 continue in the same way.
5. The winning team will be the one whose No 4 is first across the finish line, correctly mounted.
6. If a mug is dropped during an attempt to place it onto a pole, the rider may dismount to collect it and may place it while dismounted.
7. The rider must remount before continuing to the next pole.
8. Poles knocked over must be replaced before proceeding.

### **EQUIPMENT PER LANE**

- 4 bending poles, 1.2-1.5m high.
- 2 plastic or tin mugs.

## 25. NEWSPAPER RACE

A mail box will be placed on the centre line.

A newspaper stand will be placed 3m behind the changeover line.

Four newspapers will be placed on the stand.

The Team Manager (the 'paper boy'), will stand behind the newspaper stand.

1. All four riders will start behind the start/finish line.
2. On the start signal, No.1, carrying a newspaper and a coin, will post the newspaper completely through the mail box, continue across the changeover line and exchange the coin for another newspaper from the paper boy, then return to the start, handing it over to No. 2.
3. No.'s 2, 3 and 4, each of whom has a coin, will continue in the same way.
4. The winning team will be the one whose No. 4 is first across the finish line, correctly mounted and carrying a newspaper, with the paper boy holding up four coins.
5. The newspaper must be pushed through the mail box and not pulled from the other side.
6. Should the mail box be knocked over, it must be reset and the rider may dismount to do so.
7. At the newspaper stand, either the rider or the paper boy may pick up any fallen items, but the rider may not recross the line until this is done.
8. The Team Manager must remain behind the stand.

### EQUIPMENT PER LANE

- 5 folded newspapers.
- 4 'coins'; plywood discs, 10-12cm diameter.
- 1 mailbox, 1.2m x 60cm trestle/door, slotted into two feet to hold it upright, with a mail slot approx. 15cm x 5cm.
- 1 newspaper stand, a drum or upturned litter bin, 45-76cm high. A circular plywood top may be fixed to the upturned litter bin.
- The Team Manager (the paper boy) will stand behind the newspaper stand.

## 26. NINE RING RACE

The Team Manager will stand 3m beyond the changeover line, holding the stand.

Two rings will be hanging on each of the four hooks.

A post will be placed on the centre line with its' hook facing the start.

1. All four riders will start behind the start/finish line.
2. On the start signal, No.1, carrying a ring, will ride to the post on the centre line and place the ring onto the hook, continue to the changeover end to take two rings from the stand. He will then place one of the rings on the centre line post and return to the start, handing over the second ring to No. 2.
3. No.'s 2, 3 and 4 will continue in the same way. No.4 will place BOTH rings on the centre line post on the way to the finish.
4. The winning team is the one whose No.4 is first across the finish line, correctly mounted and with all nine rings hanging on the hook on the centre line post.
5. The Team Manager may not tilt the stand or give any assistance to the riders.
6. Rings dropped or dislodged from the stand or the post must be picked up and placed by the rider concerned and may be placed while dismounted.

### EQUIPMENT PER LANE

- 9 plastic or rubber rings, 10cm diameter.
- 1 wooden T shaped stand, 1.2m high with a 90cm crosspiece with 4 equally spaced cup hooks on the underside.
- 1 post, 1.2m high, with a hook or angled dowel fixed to one side, long enough to hold 9 rings.

## 27. OLD SOCK RACE

Four rolled up socks will be placed in a 50cm marked circle 3m beyond the changeover line.

A bucket will be placed on the centre line.

1. All four riders will start behind the start/finish line.
2. On the start signal, No.1, carrying a sock, will ride to his team's bucket, drop the sock into it, continue to the changeover end, dismount to pick up another sock, remount and return to the start, handing it over to No. 2.
3. No.'s 2, 3 and 4 will continue in the same way, with No. 4 dropping the fifth sock into the bucket on the way back.
4. The winning team will be the one whose No.4 is first across the finish line, correctly mounted, with all five socks in the bucket.
5. Riders must be mounted when dropping the sock into the bucket. If the sock misses the bucket, the rider may dismount to collect it and can put it into the bucket while dismounted but, must then remount to continue.
6. Riders must dismount to pick up a sock and may do so at any point after they have successfully dropped their sock into the bucket.
7. Should a rider knock over a bucket, he must reset it and replace any socks knocked out and may do so dismounted but must then remount to continue.
8. Lane Stewards should replace socks knocked out of the circle when safe to do so.

### EQUIPMENT PER LANE

- 5 socks rolled up and stitched, approx. 88mm diameter.
- 1 10 litre plastic bucket.

## 28. PONY CLUB POLE RACE

Seven 'lettered' cartons will be lined up in any order inside a 50cm marked circle, 3m beyond the changeover line.

A bending pole will be placed on the centre line.

1. All four riders will start behind the start/finish line.
- (Oct 2010) 2. On the start signal, No 1, carrying the B carton, will ride to the centre line, place it over the pole, continue across the changeover line, dismount to collect the U carton, remount and place the carton on the centre line pole, return to cross the changeover line, dismount to collect the L carton and return to the start line, handing it over to No 2.
3. No. 2 will place the L carton on the pole, continue to pick up the C carton, place it on the pole, then pick up the Y carton and return to the start line, handing it over to No. 3.
4. No. 3 will place the Y carton on the pole, continue to pick up the N carton, place it on the pole, then pick up the O carton and return to the start line, handing it over to the No. 4.
5. No. 4 will place the O carton on the pole, continue to pick up the P carton, place it on the pole and returns to the start.
6. The winning team will be the one whose No. 4 is first across the finish line, with all cartons placed on the pole to spell PONY CLUB from top to bottom.
- (Oct 2010) 7. Cartons must be placed the correct way up and in the correct order. Errors must be corrected by the rider concerned.
8. Lane Stewards should replace cartons knocked out of the circle, when safe to do so.

### EQUIPMENT PER LANE

- 1 bending pole, 1.2m-1.5m high.
- 8 cylindrical cartons, such as 1litre detergent bottles, with the top and bottom cut off to approx. 15cm length, each marked 3 times with one letter to spell PONYCLUB.
- Cut the top end a little narrower (approx. 5cm diameter) than the base, so that the cartons slot over each other.

## 29. PONY CLUB RACE

An upturned litter bin will be placed on the centre line.

On the top of the bin will be placed eight individual letters, spelling PONY CLUB, stacked in any order, one on top of the other.

The Team Manager will stand 3m beyond the changeover line holding the stand.

1. All four riders will start behind the start/finish line.
2. On the start signal, No.1 will ride to the bin and collect two letters, continue across the changeover line and hang the letters in the correct position on the stand.
3. No.'s 2, 3 and 4 will continue in the same way to spell PONY CLUB.
4. The winning team will be the one whose No. 4 is first across the finish line, correctly mounted and with all letters placed correctly on the stand.
5. Letters hung in the wrong position, and collecting the wrong number of letters, must be corrected immediately by the rider concerned.
6. If a letter is dropped while being hung on the stand, the rider may dismount to pick it up, but letters must always be hung mounted.
7. The Team Manager may not tilt the stand or give any assistance to the riders.

### EQUIPMENT PER LANE

- 1 drum or upturned litter bin, 45-76cm high. A circular ply top may be fixed to the upturned litter bin.
- 8 plywood letters, 20x20cm square, individually lettered to spell PONY CLUB, each with a hole at the centre near the top.
- 1 50mmx50mm timber post, 2m high, with two 50mmx50mm cross arms each 90cm long.
- 8 25mm cup hooks, screwed to the underside of the cross arms, two on each side of the post.

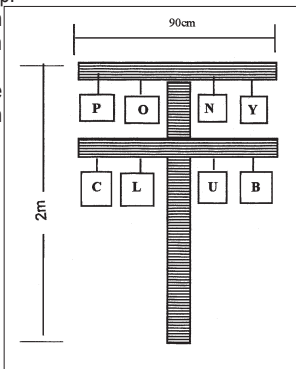

### **30. PONY EXPRESS RACE**

A line of four bending poles will be placed 9m apart, the first pole 14m from the start line.

4 letters will be placed on the ground, on the centre line.

1. Numbers 1 and 3 will start behind the start/finish line. No.'s 2 and 4 will start behind the changeover line.
2. On the start signal, No.1, carrying a sack, will bend to the centre line, dismount, pick up a letter and put it into the sack before remounting, mount and bend to the changeover end, keeping the same pattern, to hand over the sack to No. 2.
3. No.'s 2, 3 and 4 will continue in the same way.
4. The winning team will be the one whose No. 4 is first across the finish line, correctly mounted and with all four letters in the sack.
5. The rider must be mounted when passing the second bending pole and remounted before passing the third bending pole.

#### **EQUIPMENT PER LANE**

- 4 bending poles, 1.2-1.5m high.
- 1 cloth sack, 50cm deep x 40cm wide.
- 4 plywood letters, 20x10cm, with rounded corners.

## 31. POSTMAN'S CHASE

A line of four bending poles will be placed 9m apart, the first pole 14m from the start line.

The Team Manager will stand 3m beyond the changeover line holding 4 letters.

1. All four riders will start behind the start/finish line.
2. On the start signal, No.1, carrying a sack, will bend through the poles, continue across the changeover line and collect a letter from the Team Manager, place it in the sack and bend back to the start line, to hand over to No. 2.
3. No.'s 2, 3 and 4 will continue in the same way.
4. The winning team will be the one whose No. 4 is first across the finish line, correctly mounted, with all four letters in the sack.
5. The letter must be in the sack, and the rider's hand out of the sack, before crossing the start/finish line to hand over to the next rider.
6. The top of the sack may not be rolled down.
7. The Team Manager must remain behind the changeover line and, if necessary, may hold the rein of the pony while the rider puts the letter in the sack.

### EQUIPMENT PER LANE

- 4 bending poles, 1.2-1.5m high.
- 1 cloth sack, 50cm deep x 40cm wide.
- 4 plywood letters, 20x10cm, with rounded corners.

## 32. POTATO PICKING SCRAMBLE

10 potatoes (2 spare) will be placed inside a 50cm marked circle on the centre line.

A bucket will be placed inside a 50cm marked circle 3m beyond the changeover line.

1. Numbers 1 and 2 will line up side by side behind the start/finish line. No.'s 3 and 4 will be behind the 6m line.
2. On the start signal, the first pair of No.'s 1 and 2 will ride to the pile of potatoes, dismount, each pick up a potato, remount and continue across the changeover line to drop them into the bucket.
3. They will then return to the potatoes, dismount, each collect another potato, continue across the changeover line and drop them into the bucket, then return to the start.
4. The second pair of riders, No.'s 3 and 4, will continue in the same way, each picking up two potatoes in succession.
5. The winning team will be the one whose final pair of riders is first across the finish line, correctly mounted.
6. The second pair of riders may not start until both No.'s 1 and 2 have crossed the line.
7. Riders must be mounted when dropping the potato into the bucket. If a potato misses the bucket, the rider may dismount to collect it and can put it into the bucket while dismounted.
8. Riders must remount to continue, but may dismount after crossing the changeover line to collect a potato.
9. If a bucket is knocked over, the rider may dismount to reset it and may replace any spilled potatoes while dismounted.

### EQUIPMENT PER LANE

- 10 potatoes.
- 1 10 litre plastic bucket.

### 33. POTATO RACE

Six potatoes (2 spare) will be placed inside a 50cm marked circle 3m beyond the changeover line.

A bucket will be placed on the centre line.

1. All four riders will start behind the start/finish line.
2. On the start signal, No.1, carrying a potato, will ride to his team's bucket and drop the potato into it. He will then continue to the changeover end, dismount, pick up a potato, remount and return to the start, handing it over to No. 2.
3. No.'s 2, 3 and 4 will continue in the same way, with No. 4 dropping the fifth potato into the bucket on the way back.
4. The winning team will be the one whose No. 4 is first across the finish line, correctly mounted.
5. Riders must be mounted when dropping the potato into the bucket. If a potato misses the bucket, the rider may dismount to collect it and can put it into the bucket while dismounted.
6. Riders must remount before continuing, but may dismount before crossing the changeover line to collect a potato.
7. If a bucket is knocked over, the rider may dismount to reset it and may replace any spilled potatoes while dismounted.
8. Lane Stewards should replace any potatoes knocked out of the circle when safe to do so.

#### EQUIPMENT PER LANE

- 7 potatoes.
- 1 10 litre plastic bucket.

## 34. PYRAMID RACE

An upturned litter bin will be placed on the centre line and another 3m beyond the changeover line.

Four 'lettered' containers will be placed side by side on the changeover end bin.

1. All four riders will start behind the start/finish line.
2. On the start signal, No.1 will ride to the changeover end, pick up the Y container, put it down on the centre line bin and return to the start.
3. No.'s 2, 3 and 4 will continue in the same way, with No.2 picking up the N container, No. 3 the O container and No. 4 the P container.
4. The winning team will be the one whose No. 4 is first across the finish line, correctly mounted and with four containers stacked on the centre line bin to spell PONY from top to bottom.
5. The stack of containers on the centre line bin may not be straightened by hand. A rider may use the container in his hand to do so.
6. Dropped containers must be picked up immediately by the rider concerned, who may dismount to do so.
7. Containers dropped or spilled while being put on the centre line bin, must be picked up and restacked and the rider may do so dismounted.
8. If a bin is knocked over, it must be reset and any spilled containers replaced.

### EQUIPMENT PER LANE

- 2 drums or litter bins, 45-76cm high. A circular ply top may be fixed to the upturned litter bins.
- 4 x 2 litre ice cream containers, lightly weighted with sawdust (approx. 450gms) and with lids securely taped. Each container will have one letter of the word PONY painted or taped on each side.

## 35. RING RACE

A post will be fixed 3m behind the changeover line.

On one side of the post, facing away from the play area, will be fixed a piece of dowelling.

On the centre line will be a second post, from which four rings will be hung from four pieces of dowelling, facing the start line.

1. All four riders will start behind the start/finish line.
2. On the start signal, No.1, carrying a ring, will ride to the changeover end post, hang the ring on the dowel then return to the start, collecting a ring from the centre line post on the way and handing it over to No. 2.
3. No.'s 2, 3 and 4 will continue in the same way.
4. The winning team will be the one whose No. 4 is first across the finish line, correctly mounted and carrying the last ring, with four rings hanging on the post at the changeover end.

### EQUIPMENT PER LANE

- 5 plastic or rubber rings, 10cm diameter.
- 1 post, 1.2m high, with 4 angled dowels, or similar, fixed to one side in a vertical line, approx. 12cm apart.
- 1 post, 1.2m high, with a hook or angled dowel fixed to one side, long enough to hold 4 rings.

## 36. ROPE RACE

A line of four bending poles will be placed 9m apart, the first pole 14m from the start line.

1. Numbers 1 and 3 will start behind the start/finish line. No.'s 2 and 4 will start behind the changeover line.
2. On the start signal, No.1, carrying a rope, will bend through the poles, across the changeover line and turn.
3. No. 2 will grasp one end of the rope and the pair will bend through the poles and across the start line, where No.1 will release the rope and drop out and No. 2 will turn.
4. No. 3 will grasp the end of the rope and the pair will bend through the poles and across the changeover line, where No. 2 will release the rope and drop out and No. 3 will turn.
5. No. 4 will grasp the end of the rope and the pair will bend through the poles and across the finish line.
6. The winning team will be the one whose final pair of No.'s 3 and 4 is first across the finish line, correctly mounted and holding the rope.
7. Should a rider release the rope while in the play area, the pair must go back and resume the race from the point where the error occurred.
8. The rope must not be knotted at the ends. Nor may it be looped when held between the riders.
9. Poles knocked completely down to the ground may be replaced by either of the two riders concerned.
10. Riders may continue if a pole is only partially knocked over, provided they can do so correctly.
11. Poles completely broken off will result in the elimination of the team.
12. Lane Stewards will not signal unless the pole is broken or lying flat on the ground.

### EQUIPMENT PER LANE

- 4 bending poles, 1.2-1.5m high.
- 1 length of rope, 90cm long, approx. 15mm diameter.

### **37. RUN AND RIDE**

A line of 5 bending poles will be placed 9m apart, the first pole 14m from the start line.

1. All four riders will start behind the start/finish line.
2. Numbers 1 and 3 begin dismounted and No's 2 and 4 begin mounted.
3. On the signal to start, No1 will run beside the poles to pole 5 leading his pony, turn around the pole before mounting and riding back across the start/finish line.
4. No 2 will ride to pole 5 and dismount BEFORE turning around the pole and running back across the start/finish line leading his pony.
5. No's 3 and 4 will continue in the same way.
6. The winning team will be the one whose No 4 is first over the finish line leading his pony.
7. No 3 must remain mounted behind the 6m line until No 2 has crossed the start line.
8. Pole 5 must remain upright at ALL times.
9. Ponies must be led by the nearest rein only.

#### **EQUIPMENT PER LANE**

- 5 bending poles, 1.2-1.5m high.

## **38. SACK RACE**

1. Numbers 1 and 3 will start behind the start/finish line. No.'s 2 and 4 will start behind the changeover line.
2. On the start signal, No. 1, carrying a sack will ride forward, dismount before crossing the centre line, get into the sack, and hop or jump to the changeover end leading his pony, then get out of the sack and hand it to No. 2.
3. No.'s 2, 3 and 4 will continue in the same way.
4. The winning team will be the one whose No. 4 is first across the finish line, leading his pony and with both feet in the sack..
5. Getting out of the sack and handing it over, must be done behind the start or changeover lines.
6. Riders must be on their feet when crossing the line, and the pony must be held by the nearest rein only, without holding on to any part of the pony or saddlery.
7. Reins must remain over the pony's neck.
8. Riders must not attempt to get into the sack until they have dismounted.

### **EQUIPMENT PER LANE**

- 1 hessian sack.

## 39. SHARP SHOOTERS RACE

A bale will be placed with its' back edge 3m beyond the changeover line.

Evenly spaced on the bale, will be stood six two litre milk containers.

A bucket containing 12 tennis balls will be placed just over the changeover line.

1. All four riders will start behind the start/finish line.
2. Number1 will be mounted bareback on at the start, with No 2 standing dismounted beside him. No. 3 will be mounted bareback behind the 6m line, with No. 4 standing dismounted beside him.
3. On the start signal, No. 2 will vault on behind No. 1. They will ride to the changeover end, where No. 2 will dismount and throw the ball(s) to knock over one container. It need not fall off the bale.
4. No. 2 will then remount behind No.1, before reaching the centre line, and both riders will return to the start.
5. No. 4 will vault on behind No. 3. They will ride to the changeover end, where No. 4 will dismount and throw the ball(s) to knock down one container.
6. No. 4 will then remount behind No. 3, before reaching the centre line, and both riders will continue to the finish.
7. The winning team will be the one whose final pair of No.'s 3 and 4 is first across the finish line, correctly mounted.
8. Riders vaulting on must stand facing forward and may not join hands until after the start signal, or until after the first pair has crossed the line.
9. Riders must face forward when mounted.
10. The whole of the rider's feet must remain in front of the line when throwing the ball(s).
11. There is no penalty if more than one container is knocked over, provided there is one container left for No.4.

### EQUIPMENT PER LANE

- 1 bale of hay or straw.
- 6 2 litre plastic milk containers, slightly weighted (with water).
- 1 10 litre plastic bucket.
- 12 tennis balls.

## **40. STEPPING STONE DASH**

Six stepping stones will be placed 60cm apart measured from centre to centre of the stone, in a straight line up and down the arena, across the centre line.

1. Numbers 1 and 3 will start behind the start/finish line. No.'s 2 and 4 will start behind the changeover line.
2. On the start signal, No.1 will ride towards the stepping stones, dismount and, leading his pony, will step on each stone and then the ground, before remounting to cross the changeover line.
3. No.'s 2, 3 and 4 will continue in the same way.
4. The winning team will be the one whose No. 4 is first across the finish line, correctly mounted.
5. After negotiating the stones, riders must step onto the ground before remounting.
6. Should a stepping stone be knocked over, or a rider step on the ground while negotiating the stones, it must be reset and the rider must return to step over all the stones again.
7. Riders must lead the pony by the nearest rein, without holding on to any part of the pony or saddlery.
8. Reins must remain over the pony's neck.

### **EQUIPMENT PER LANE**

- 6 stepping stones, 18-20cm high x approx 20cm diameter blocks of wood, or heavy duty plastic flower pots.

## 41. SWORD RACE

A line of four bending poles will be placed 9m apart, the first pole 14m from the start.

A ring will be attached to the top of each pole.

1. Numbers 1 and 3 will start behind the start/finish line. No.'s 2 and 4 will start behind the changeover line.
2. On the start signal, No. 1, carrying a sword, will ride to the changeover end, collecting one of the rings on the way, then hand over the sword to No. 2
3. No.'s 2, 3 and 4 will continue in the same way.
4. The winning team will be the one whose No. 4 is first across the finish line, correctly mounted and with four rings on the sword.
5. Should a ring be dropped, the rider may dismount to pick it up. This is the only time the ring may be touched by hand.
6. The sword may be held by the blade if the rider dismounts to correct an error. At all other times, the sword must be held by the handle.
7. If a sword is broken, the rider may continue, provided it is possible to complete the race correctly.
8. There is no penalty should a pole be knocked down.

### EQUIPMENT PER LANE

- 4 bending poles, 1.2-1.5m high.
- 4 metal/wire rings, 10cm inner diameter, attached securely to the tops of the poles, such as with rubber bands.
- 1 sword, light wooden or 20mm plastic tubing with the ends taped, total length 60cm; handle 20cm, blade 40cm, cross piece 20cm.
- rubber bands.

## 42. TACK SHOP RACE

A pole will be placed 14m from the start/finish line.

Attached will be a container, the 'money box'.

A plastic grooming tray will be placed on top of an upturned litter bin 14m from the changeover line.

The Team Manager will stand behind another upturned litter bin placed 3m behind the changeover line. On the bin will be placed a dandy brush, a sponge, a tail bandage and a hoof pick.

1. All four riders start behind the start/finish line.
2. On the start signal, No. 1, carrying a coin, will ride up the arena to place it in the money box, pick up the grooming tray, continue across the changeover line, where the Team Manager will place one of the items into the tray.  
The rider will then return the tray to the first bin, collect the coin from the money box and return to the start, handing it over to the No. 2.
3. Riders 2, 3 and 4 will continue in the same way.
4. The winning team will be the one whose No. 4 is first across the finish line, correctly mounted and carrying the coin.
5. If an item is dropped behind the changeover line, either the rider or the Team Manager may pick it up but it must be in the tray before the rider re-crosses the changeover line.  
The Team Manager may hold the rein of the pony behind the changeover line.

### EQUIPMENT PER LANE

- One bending pole, 1.2-1.5m high.
- 1 plastic or metal container, approx. 20cm square/diameter, 5 cm deep, fixed to the top or side of the pole.
- 2 drums or upturned litter bins 45 - 76cm high. A circular plywood top may be fixed to each upturned bin.
- 1 plastic grooming tray.
- 1 dandy brush, 1 sponge, 1 tail bandage, 1 hoof pick.
- 1 'coin'; plywood disc, 10-12cm diameter.

(Oct 2010)

(Oct 2010)

### **43. THREE LEGGED SACK RACE**

1. Numbers 1 and 3 will start at the start/finish line. No.'s 2 and 4 will start behind the changeover line.
2. On the start signal, No. 1, carrying a sack, will ride up the arena, across the changeover line and dismount.
3. No. 2 will dismount after No. 1 has crossed the line.
4. No.'s 1 and 2 will each put one leg into the sack, before crossing the changeover line, and hop or run to the start line, leading their ponies.
5. Once the first pair is across the start line, the sack will be handed to No. 3 who will ride down the arena, across the changeover line and dismount.
6. No. 4 will dismount after No. 3 has crossed the line.
7. No.'s 3 and 4 will each put one leg into the sack, before crossing the changeover line, and hop or run to the start line, leading their ponies.
8. The winning team will be the one whose final pair of No.'s 3 and 4 is first across the finish line, each with one foot in the sack and leading their ponies correctly.
9. Each rider must hold the sack with one hand.
10. The sack must be held above the knees.
11. If a rider drops the sack, or falls out of the sack, the error must be corrected and the race resumed from the point where the error occurred.
12. Ponies must be held by the nearest rein, without holding onto any part of the pony or saddlery.
13. Reins must remain over the ponies' necks.

#### **EQUIPMENT PER LANE**

- 1 hessian sack.

## 44. THREE MUG RACE

A line of four bending poles will be placed 9m apart, the first pole 14m from the start.

A mug will be placed on poles 1, 2 and 3.

1. All four riders will start behind the start/finish line.
2. On the start signal, No. 1 will move the mug on pole 3 to pole 4, the mug on pole 2 to pole 3 and the mug on pole 1 to pole 2, then return to the start.
3. No. 2 will move the mugs back, from pole 2 to pole 1, from pole 3 to pole 2 and from pole 4 to pole 3.
4. No.'s 3 and 4 will continue in the same way.
5. The winning team will be the one whose No. 4 is first across the finish line, correctly mounted and with the mugs on the correct poles.
6. If a mug is dropped while being put on a pole, the rider may dismount to collect it and may put it on the pole from the ground.
7. If a mug is dropped while being picked up from a pole, the rider may dismount to collect it, but must remount to continue to the next pole to put it down.

### EQUIPMENT PER LANE

- 4 bending poles, 1.2-1.5m high.
- 3 plastic or metal mugs.

## **45. TWO FLAG RACE**

A flag holder will be placed 14m from both the start and changeover lines.

A flag will be placed in the holder nearest the changeover end.

1. Numbers 1 and 3 will start behind the start/finish line. No.'s 2 and 4 will start behind the changeover line.
2. On the start signal, No.1, carrying a flag, will put it into the first holder, continue to the next holder, pick up the flag and hand it over to No. 2.
3. No.'s 2, 3 and 4 will continue in the same way.
4. The winning team will be the one whose No. 4 is first across the finish line, correctly mounted and carrying the flag.
5. Fallen holders must be reset by the rider concerned, who may dismount to do so.
6. Dropped flags must be picked up by the rider concerned, and the flag may then be put into the holder while dismounted.
7. If a flag comes off a cane, the cane may be used to complete the race.

### **EQUIPMENT PER LANE**

- 2 flag holders, road cones 45cm high, with tops cut off to leave a 10cm diameter hole.

## 46. WINDSOR CASTLE RACE

A road cone (the castle) will be placed on the centre line.

A bucket (the moat) will be placed halfway between the centre and changeover lines.

1. Numbers 1 and 3 will start behind the start/finish line. No.'s 2 and 4 will start behind the changeover line. No.1 carries the turret and No. 2 carries the orb.
- (Oct.2010) 2. On the start signal, No 1, carrying the turret, will ride up the arena to place it on the castle, then continue across the changeover line.
3. No 2, carrying the orb, will ride down the arena to place it on top of the turret, then continue across the start line.
4. No. 3 (the thief) will steal the orb and drop it into the bucket (moat) then continue to the changeover end.
- (Oct.2010) 5. No 4 will rescue the orb (from the moat), replace it on the turret and continue across the finish line.
6. The winning team will be the one whose No. 4 is first across the finish line, correctly mounted and with the castle correctly assembled.
7. Dropped equipment may be picked up either mounted or dismounted.
8. Equipment knocked over must be reset immediately by the rider concerned.
9. If the moat (bucket) is knocked over, it must be reset by the rider, but need not be refilled.
10. The orb may be picked up from the moat either mounted or dismounted but, if the rider dismounts, they must remount to continue to the castle.

### EQUIPMENT PER LANE

- 1 road cone, approx. 76cm high, the castle.
- 1 wooden or plastic turret, painted silver, shaped to fit over the castle, with an upper diameter of approx. 5cm to receive the orb.
- 1 circular orb, painted gold, approx. 7cm diameter.
- 1 10 litre plastic bucket, about  $\frac{3}{4}$  full of water.

## 47. BARREL RACE

**INTERNATIONALLY, THE BARREL RACE (44) AND KEYHOLE RACE (45) GAMES ARE NOT CONSIDERED TO BE TRUE TEAM RELAY RACES. THEY CAN, HOWEVER, BE SET UP OUTSIDE A STANDARD GAMES ARENA**

1. All four riders will start behind the start/finish line.
2. See diagram for drum placement and measurements.
3. On the start signal, No.1 will ride the course as shown on the diagram.
4. No.'s 2, 3 and 4 will continue in the same way.
5. The winning team will be the one with the fastest overall time.
6. Each rider must be through the finish flags before the next rider can start.
7. The total time for the team will be used for the final placings.
8. Course errors not rectified will result in elimination of the team.

### EQUIPMENT PER LANE

- 3 drums, with padded tops.
- 3 flags; two red and one white. The red flags to be placed 2m either side of the white flag on the start/finish line.

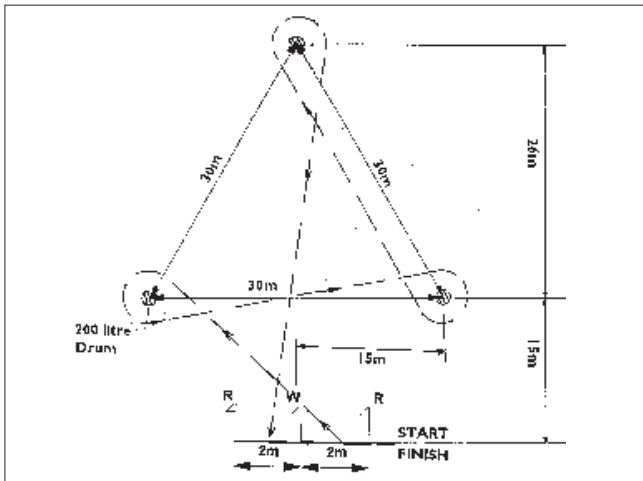

## 48. KEYHOLE RACE

1. All four riders will start behind the start/finish line.
2. A keyhole will be painted onto the ground as per the diagram.
3. On the start signal, No.1 will ride over the start line, through the mouth of the keyhole and turn either left or right in the circle, returning through the mouth of the keyhole and back over the finish line.
4. No.'s 2, 3 and 4 will continue in the same way.
5. The winning team will be the one with the fastest overall time. If a pony steps out, on or over the painted lines, the Lane Steward will raise their arm and call "Out". The rider must exit from the keyhole, pass the marker poles, turn and complete the keyhole again, without stepping on the line.
6. If a rider fails to negotiate the keyhole correctly, the team will be eliminated.

### EQUIPMENT PER LANE

- 1 white flag.
- 2 red flags.
- 2 marker poles.
- Paint for keyhole

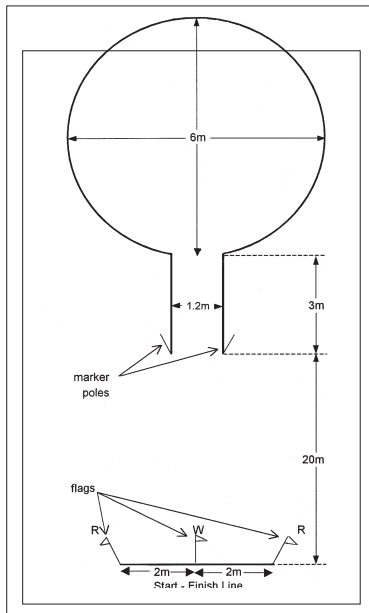

## APPENDIX 1: General

- (Oct. 2010) • All games will be run in heats with arenas set up for six or seven lanes.
- Quantities given for each game are for one lane only. These are the minimum requirements and spares should be available in case of breakages.
- All equipment used must be identical for every lane.
- Bending poles may be left in the ground to define lanes for games that do not use the poles.
- (Oct. 2010) • Equipment positioned between lines of bending poles should be set to the side which allows the maximum distance for riders to pull up to the right. Refer to 27n).

### Notes to the Arena Plan

- The Arena must be roped.
- (Oct. 2010) • The Arena is defined as the roped area 76m x 100-103m, i.e. an extra 3m may be added to the area behind the 6m line at the changeover end.
- If 7 lanes are used, an extra 8m should be added for the 7th lane and start/finish and changeover lines lengthened accordingly, i.e. arena width will be 84m.
- The play area is defined as the area between the changeover line and the Start/Finish line.
- The gates must be shut when games are in play.
- (Oct. 2010) • In games where equipment, or the manager, or fifth member is positioned 3m beyond the changeover line, a circle (50cm diameter) should be marked with paint.
- There may be a mark on the ground on the centre line to position equipment.

# PLAN OF ARENA

(to be read in conjunction with the 'Notes to the Arena Plan')

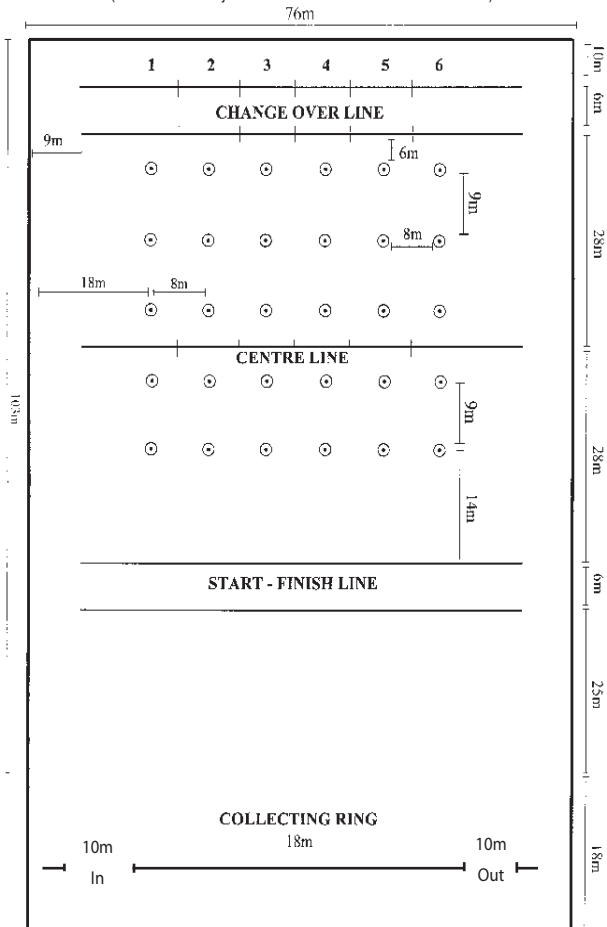

Start/finish and change lines should be marked by a painted/mown line as well as flags.

## APPENDIX 2:

### THE BRIEFING

The briefing is conducted by the Official Steward. It should take place not less than one hour before the start of the first game.

The Official Steward should be given a list of all arena personnel.

Before the briefing begins the Official Steward should call the roll to ensure that everyone is present.

Those required are:

Team Managers or Coaches	Lane Stewards	The Chief Judge	
The Starter	Time Keepers	Line Stewards	Team Captains may be invited

The briefing will include a summary of Rule 23: Concussion and Injury; Rule 25: Objections; Rule 27: General Game Rules; and a brief description of the games and special points that need attention. The Official Steward will verify that everyone present understands their duties and will ensure that all questions and answers are heard, highlighting the following:

#### Lane Stewards

- The Lane Steward signals are for the guidance of the Official Steward and not for the competitors.
- The signalling procedures should be demonstrated and a reminder that they must not call back into the playing area or warn any competitor.
- Reminder that they must not judge their own team.
- Stress the need for absolute concentration while the game is in progress.
- See Rule 33.

#### Time Keepers

- Responsible for timing the heats and finals in their lane.
- Time commences at the drop of the flag and stops when the horses head crosses the line when ridden, or when the rider crosses the line when unmounted, or when the head of the second pony crosses the line in a game for pairs.
- See Rule 32.

### **Starter**

- The Starter alone is responsible to see that the start is fair.
- The starting position is in line with the first line of bending posts.
- In the event of a false start the starter will immediately blow the whistle and raise his flag.
- The Starter should communicate with the Timekeepers, Lane Stewards and Line Stewards before each heat/final to ensure they are ready i.e. watches set, 1 minute to go.
- See Rule 27(c) and Rule 31.

(Oct 2010)

### **Chief Judge**

- Responsible for determining the results of the heats and finals and reporting the results to the Scorer and the Commentator.
- See Rule 29.

## **APPENDIX 3:**

### **DRESS - REFER TO RULE 20(G)**

Explanatory note:

\*Competitions include Horse Trials, Dressage, Show Jumping and Team Mounted Games, ie. all championships, ODE's, SJ days etc.

\*The top half of the two piece boots are known as gaiters and sometimes referred to as chapettes or ½ chaps.

\*A gaiter is defined as a piece of leather from below the knee down to the ankle.

\*Gaiters, chapettes or ½ chaps made of cloth or suede are NOT permitted.

## **APPENDIX 4 - Prohibited Substances**

Horses taking part in a Competition must be healthy and compete on their inherent merits. The use of a Prohibited Substance might influence a Horse's performance or mask an underlying health problem and could falsely affect the outcome of a competition. The list of Prohibited Substances has been compiled to include all categories of pharmacological action.

1. Prohibited Substances are substances originating externally, whether they are endogenous to the horse or not
  - Substances acting on the nervous system.
  - Substances acting on the cardiovascular system.
  - Substances acting on the respiratory system.
  - Substances acting on the digestive system.
  - Substances acting on the urinary system.
  - Substances acting on the reproductive system.
  - Substances acting on the musculoskeletal system.
  - Substances acting on the skin (e.g. hypersensitising agents).
  - Substances acting on the blood system.
  - Substances acting on the immune system, other than those in licensed vaccines.
  - Substances acting on the endocrine system, endocrine secretions and their synthetic counterparts.
  - Antipyretics, analgesics and anti-inflammatory substances.
  - Cytotoxic substances.
2. List of substances for which maximum threshold levels or ratios have been established.

#### APPENDIX 4 (cont'd) - Prohibited Substances

Available Carbon Dioxide	37 millimoles per litre in plasma
Dimethyl Sulfoxide	15 micrograms per millilitre in urine OR 1 microgram per millilitre in plasma
Hydrocortisone	1 microgram per millilitre in urine
Nandrolone	free and conjugated 5 $\alpha$ -estrane-3 $\beta$ , 17 $\alpha$ -diol to 5(10)-estrane-3 $\beta$ , 17 $\alpha$ -diol in urine at a ratio of 1.
Salicylic Acid	750 micrograms per millilitre in urine OR 6.5 micrograms per millilitre in plasma
Testosterone (Geldings)	free and conjugated testosterone 0.02 microgram per millilitre in urine
Testosterone (fillies and mares)	free and conjugated testosterone to epitestosterone 12:1 in urine
Theobromine	2 micrograms per millilitre in urine
Total Arsenic	0.3 microgram per millilitre in urine

## APPENDIX 5 - Snaffle Bits permitted for NZPCA Team Mounted Games



(i)

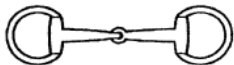

(ii)



(iii)

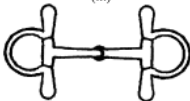

(iv)

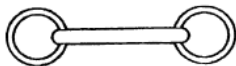

(v)

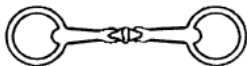

(vi)



(vii)a



(vii)b

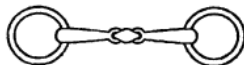

(vii)c

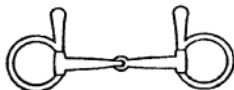

(viii)

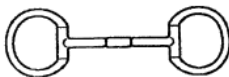

(ix)

### Permitted bits:

- (i) Loose ring snaffle; (ii) Egg-butt snaffle; (iii) D-ring snaffle
- (iv) Egg-butt snaffle with cheeks or Full Spoon Cheek snaffle (or loose ringed Tom Thumb)
- (v) Straight bar snaffle; permitted also with mullen mouth and with egg-butt rings
- (vi) Double jointed snaffle with rotating middle piece
- (vii) a, b & c Double jointed snaffle provided there is only one mouthpiece. A Dr Bristol bit, i.e. where the link plate is long, flat and set at an angle, is NOT classed as an ordinary double jointed snaffle.
- (viii) Snaffle with upper cheeks only
- (ix) Snaffle with rotating mouthpiece.

Vulcanite, rubber and nylon bits are permissible, provided they comply with the above.